

Freedom Designs – Seating & Positioning Order Form Version 1

email it!



Freedom Designs, Incorporated
 2241 N Madera Road, Simi Valley, CA 93065
 phone: 800-331-8551 fax: 888-582-1509
 e: customerservice@freedomdesigns.com
 www.freedomdesigns.com

Buyer: _____
 Co./Account: _____
 Location: _____
 Contact #: _____
 P.O. #: _____
 Marked For: _____
 Fax: _____
 Email: _____

Quote Order

Chair Model: _____
 Chair Width: _____
 Chair Depth: _____
 Back Height: _____
 Tube Size: _____
 Upholstery Color: _____
 Contact: _____ Non Contact: _____

4 Point Mount	
Drop Hook	\$439 ea
<input type="checkbox"/> 1" <input type="checkbox"/> 2" <input type="checkbox"/> 3"	
<input type="checkbox"/> Seat <input type="checkbox"/> Back	
Easy Clamp	\$568 ea
<input type="checkbox"/> Seat <input type="checkbox"/> Back	
J/L Collar Clamp	\$465 ea
<input type="checkbox"/> Seat <input type="checkbox"/> Back	
J/L Q Release	\$590 ea
<input type="checkbox"/> Seat <input type="checkbox"/> Back	
Rotate Hold Down	\$453 ea
<input type="checkbox"/> Seat <input type="checkbox"/> Back	

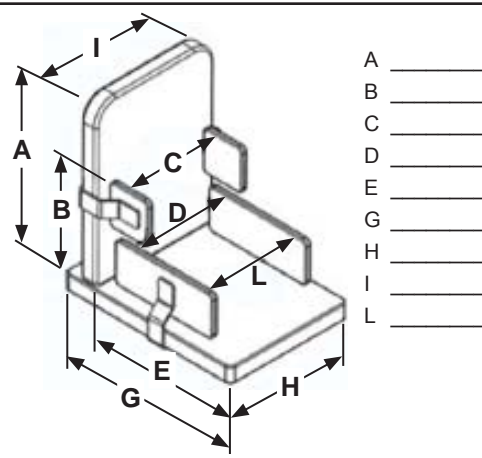

Embroidery Options

Design: _____
 Monogram: _____
 Thread: _____
 Font: _____

Seat and Back Hinged Together with Hardware

<input type="checkbox"/> EE1/EE2 \$1266 Knob Seat/Knob Back	<input type="checkbox"/> MOD-2I \$131 Curved Wood	<input type="checkbox"/> MOD-2H \$125 I-MOD	<input type="checkbox"/> MOD-2DD \$293 Adjustable Lumbar	<input type="checkbox"/> MOD-2S \$254 Free Form	<input type="checkbox"/> *MOD-1II n/c Seat
<input type="checkbox"/> EZLite1/EE2 \$1095 Snap Seat/Knob Back	<input type="checkbox"/> MOD-2IA \$113 Curved Foam	<input type="checkbox"/> MOD-2J \$125 T-MOD	<input type="checkbox"/> MOD-2GG \$414 Ergo	<input type="checkbox"/> *1/4" Applewood Base (14" wide & under only)	<input type="checkbox"/> *MOD-2KK n/c Back

Packages

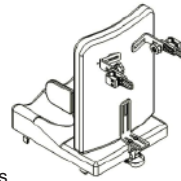
<input type="checkbox"/> FD Model 10 - EZ-Lite1 / EE2 \$1596 <ul style="list-style-type: none"> Planar Seat with 1/2" of Soft Sunmate over 1" of Medium Planar Back with 1" of Soft Sunmate EZ-Lite Seat Mount Hardware EE2 Back Mount Hardware EE5A (Straight) or EE5B (Offset) Fixed Trunk Laterals with 5" Track & Flat Pads Flip and Fold Seat to Back Bracket 	<input type="checkbox"/> FD Model 40 - EZ-Lite1 / EE2 \$2078 <ul style="list-style-type: none"> Mod-1Y ContourSeat with 1/2" of Soft Sunmate over 1" of Medium Mod-2I Curved Wood Back with 1" of Soft Sunmate EZ-Lite Seat Mount Hardware EE2 Back Mount Hardware EE5A (Straight) or EE5B (Offset) Fixed Trunk Laterals with 5" Track & Flat Pads with Straight Brackets Flip and Fold Seat to Back Bracket 
---	---

Seat Modification Options

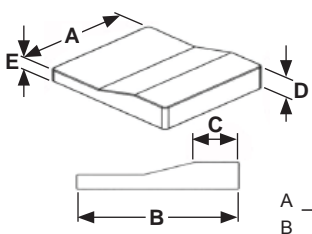
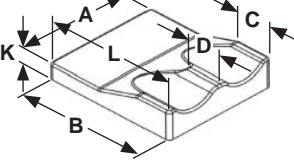
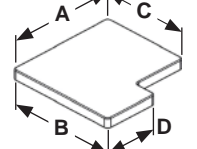
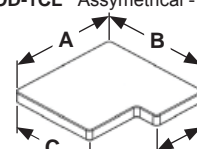
<input type="checkbox"/> MOD-1K Anti-Thrust Seat \$206  <p>Thickness Dimensions On Seats Include Foam <u>Only</u></p> <p>A _____ B _____ C _____ D _____ E _____</p>	<input type="checkbox"/> MOD-1Y Contour Seat \$320  <table border="1"> <thead> <tr> <th>Layer</th> <th>Foam Type</th> <th>Thickness</th> </tr> </thead> <tbody> <tr> <td>Top</td> <td>_____</td> <td>_____</td> </tr> <tr> <td>Middle</td> <td>_____</td> <td>_____</td> </tr> <tr> <td>Bottom</td> <td>_____</td> <td>_____</td> </tr> </tbody> </table> <p>Thickness Dimensions On Seats Include Foam <u>Only</u></p>	Layer	Foam Type	Thickness	Top	_____	_____	Middle	_____	_____	Bottom	_____	_____	<input type="checkbox"/> MOD-1CR Assymetrical - Long Right \$86  <p>A _____ B _____ C _____ D _____</p> <input type="checkbox"/> MOD-1CL Assymetrical - Long Left \$86  <p>A _____ B _____ C _____ D _____</p>
Layer	Foam Type	Thickness												
Top	_____	_____												
Middle	_____	_____												
Bottom	_____	_____												
<input type="checkbox"/> MOD-1DD Modular Contour Cushion \$424														



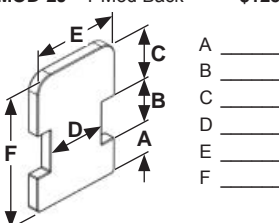
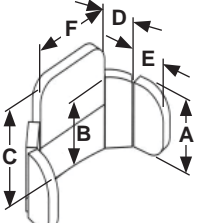
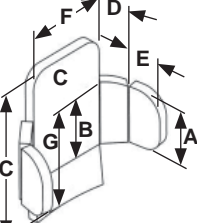
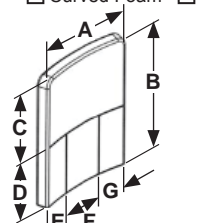



















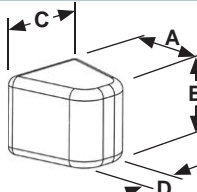
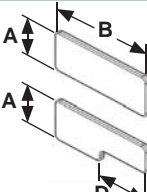

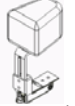
Back Modification Options

<input type="checkbox"/> MOD-2H I Mod Back \$125 <input type="checkbox"/> MOD-2J T Mod Back \$125  <p>A _____ B _____ C _____ D _____ E _____ F _____</p>	<input type="checkbox"/> 102-12000 Std. Easy Conforming \$969  <p>A _____ B _____ C _____ D _____ E _____ F _____ G _____</p>	<input type="checkbox"/> 102-13000 Ext. Easy Conforming \$969  <p>A _____ B _____ C _____ D _____ E _____ F _____ G _____</p>	<input type="checkbox"/> MOD-2S \$254 <input type="checkbox"/> Curved Foam <input type="checkbox"/> Curved Wood Free Form <input type="checkbox"/> Soft <input type="checkbox"/> Medium <input type="checkbox"/> MOD-2QQ \$226 Split Wing  <p>A _____ B _____ C _____ D _____ E _____ F _____ G _____</p>
---	--	--	--

Freedom Designs – Seating & Positioning Order Form Version 1

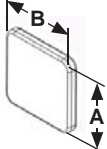
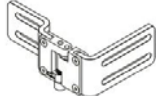
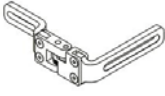
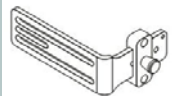
Buyer: _____
 Co./Account: _____
 Location: _____
 Contact #: _____

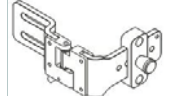
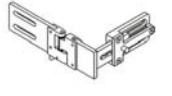
P.O. #: _____
 Marked For: _____
 Fax: _____
 Email: _____

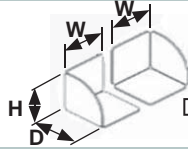
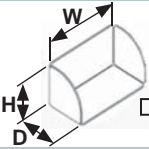
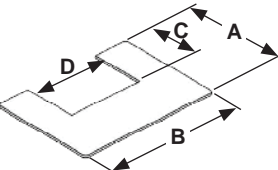
Headrests - Ala Carte				Anterior Posture Supports				
 <input type="checkbox"/> 7700 \$141 Vert. & Horz. Adj.	 <input type="checkbox"/> 7701 \$298 Multi-Adjustable	 <input type="checkbox"/> 7703 \$321 Ball & Socket	 <input type="checkbox"/> 7704 \$297 Removable	 <input type="checkbox"/> 7708 \$385 Rock & Roll	 <input type="checkbox"/> 7709 \$394 Flip Down	 <input type="checkbox"/> EE6V \$161	 <input type="checkbox"/> EE6S \$161	
						<input type="checkbox"/> Dynamic <input type="checkbox"/> Static		
 <input type="checkbox"/> 7753 \$308 3 Piece Hinged <input type="checkbox"/> S <input type="checkbox"/> M <input type="checkbox"/> L	 <input type="checkbox"/> 7756 \$184 Chubbie <input type="checkbox"/> S <input type="checkbox"/> M <input type="checkbox"/> L	 <input type="checkbox"/> 7756-Bell \$220 Chubbie Bell <input type="checkbox"/> S <input type="checkbox"/> M <input type="checkbox"/> L	 <input type="checkbox"/> 7757 \$146 Low Profile <input type="checkbox"/> S <input type="checkbox"/> M <input type="checkbox"/> L	 <input type="checkbox"/> 7760 \$184 Skinny <input type="checkbox"/> S <input type="checkbox"/> M <input type="checkbox"/> L				<input type="checkbox"/> XXSmall <input type="checkbox"/> XSmall <input type="checkbox"/> Small <input type="checkbox"/> Medium <input type="checkbox"/> Large <input type="checkbox"/> XLarge
Medial Thigh Support				Lateral Thigh Supports				
		Standard Sizes <input type="checkbox"/> Small 3L x 3H x 3-2 Taper <input type="checkbox"/> Medium 4L x 3H x 3-2 Taper <input type="checkbox"/> Large 5L x 4H x 4-2 Taper <input type="checkbox"/> X-Large 6L x 5H x 5-3 Taper Pad / Hardware Included				<input type="checkbox"/> Straight <input type="checkbox"/> 1" Offset <input type="checkbox"/> 2" Offset <input type="checkbox"/> Contour Pad <input type="checkbox"/> Best fit		
				<input type="checkbox"/> EE4D \$509 Knee Adductor <input type="checkbox"/> Small <input type="checkbox"/> Medium <input type="checkbox"/> Large				
 <input type="checkbox"/> EE3A \$232 Adjust Remove	 <input type="checkbox"/> EE3B-2 \$435 Flip / Adjust	 <input type="checkbox"/> EE3E \$435 Flip / Adjust	 <input type="checkbox"/> EE3P \$414 Flip Down	 <input type="checkbox"/> MOD-4A \$88 Custom Contour	 <input type="checkbox"/> EE4A/B \$232 L-Bracket (pr)	 <input type="checkbox"/> EE4C \$465 Quick Release (pr)	 <input type="checkbox"/> MOD-4D \$41ea Extension Bracket	
Trunk Supports								
		Foam Options <input type="checkbox"/> Standard <input type="checkbox"/> Thin <input type="checkbox"/> 4L x 3H <input type="checkbox"/> Flat <input type="checkbox"/> Curved <input type="checkbox"/> 5L x 4H <input type="checkbox"/> Sunmate <input type="checkbox"/> T-Foam <input type="checkbox"/> 6L x 5H		<input type="checkbox"/> MOD-5F \$53 Fabric Sleeve Boot <input type="checkbox"/> Other _____		EE5I Tracks \$51/pr <input type="checkbox"/> 3" Single <input type="checkbox"/> 11" Single <input type="checkbox"/> 5" Single <input type="checkbox"/> 9" Double <input type="checkbox"/> 7" Single <input type="checkbox"/> 11" Double <input type="checkbox"/> 9" Single		
 <input type="checkbox"/> EE5E \$465 Lift / Swing	 <input type="checkbox"/> EE5E Micro \$465 Lift / Swing Micro	 <input type="checkbox"/> EE5J \$394 Fixed Summer/Winter	 <input type="checkbox"/> EE5P \$522 Lever/Swing	 <input type="checkbox"/> EE5Q \$656 Lever Summer/Winter	 <input type="checkbox"/> EE5S \$656 Lever Summer/Winter	<input type="checkbox"/> MOD-5J \$41ea Extension Bracket		
Lower Leg and Foot Supports								
 Hi-Tops Static <input type="checkbox"/> EE9B <input type="checkbox"/> EE9B-D \$109 Dynamic <input type="checkbox"/> EE9F <input type="checkbox"/> EE9F-D \$166 <input type="checkbox"/> S <input type="checkbox"/> M <input type="checkbox"/> L		 Shoe Holders \$163 <input type="checkbox"/> EE9 Velcro <input type="checkbox"/> EE9C Buckle <input type="checkbox"/> S <input type="checkbox"/> M <input type="checkbox"/> L		 <input type="checkbox"/> 08-10000 \$591 Leg Cradles		 <input type="checkbox"/> 08-11000 \$505 Foot Box		
Trays								
		<input type="checkbox"/> 08-8000 Lexan Tray - No Hardware \$156		<input type="checkbox"/> 08-17000 1/4" Lexan Tray w/o Hardware \$ 93				
		<input type="checkbox"/> 08-6000 Lexan Tray - Adj. Knob Release/ Ribs \$215		<input type="checkbox"/> MOD-8J Stability Belt \$ 38 ea.				
		<input type="checkbox"/> 08-12000 EZ-Lite Lexan Tray - 1/4" Thick \$167		<input type="checkbox"/> MOD-8K Elbow Blocks \$232 pr.				
		<input type="checkbox"/> 08-13000 EZ-Lite Lexan Tray with Ribs \$179		<input type="checkbox"/> 454A Knob Release \$ 50 ea.				
		<input type="checkbox"/> 08-15000 Lexan Tray / 1" Locking Hooks \$198		<input type="checkbox"/> 454B Toggle Release \$121 ea.				
				<input type="checkbox"/> 461 Channel Bracket \$ 65 ea.				