



Freedom Designs, Incorporated

2241 N Madera Road, Simi Valley, CA 93065
 phone: 800-331-8551 fax: 888-582-1509
 e: customerservice@freedomdesigns.com



Quote Order

Yes, you can.

Buyer: _____
 Co./Account: _____
 Location: _____
 Contact #: _____
 P.O.#: _____
 Marked For: _____
 Fax: _____
 Email: _____

Chair Model: _____
 Chair Width: _____
 Chair Depth: _____
 Back Height: _____
 Tube Size: _____
 Upholstery Color: _____
 Contact: _____ Non Contact: _____

- 4 Point Mount**
- Drop Hook** \$572 ea
 1" 2" 3"
 Seat Back
 - Easy Clamp** \$770 ea
 Seat Back
 - J/L Collar Clamp** \$800 ea
 Seat Back
 - J/L Q Release** \$769 ea
 Seat Back
 - Rotate Hold Down** \$585 ea
 Seat Back

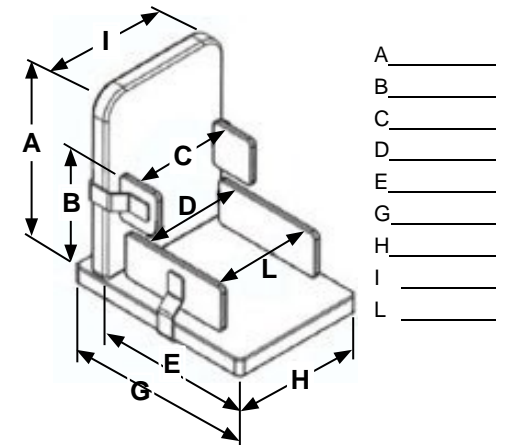

Embroidery Options

Design: _____
 Monogram: _____
 Thread: _____
 Font: _____

Seat and Back Hinged Together with Hardware

- | | | | | | |
|---|---|--|---|---|---|
| <input type="radio"/> EE1/EE2 \$1726
Knob Seat/Knob Back | <input type="radio"/> MOD-2I \$163
Curved Wood | <input type="radio"/> MOD-2H \$155
I-MOD | <input type="radio"/> MOD-2DD \$362
Adjustable Lumbar | <input type="radio"/> MOD-2S \$313
Free Form | <input type="radio"/> *MOD-1II n/c
Seat |
| <input type="radio"/> EZLite1/EE2 \$459
Snap Seat/Knob Back | <input type="radio"/> MOD-2IA \$140
Curved Foam | <input type="radio"/> MOD-2J \$155
T-MOD | <input type="radio"/> MOD-2GG \$510
Ergo | <input type="radio"/> *1/4" Applewood Base
(14" wide & under only) | <input type="radio"/> *MOD-2KK n/c
Back |

Packages

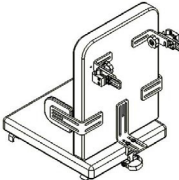
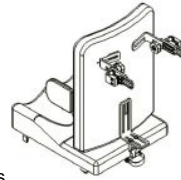
- | | |
|---|--|
| <input type="radio"/> FD Model 10 - EZ-Lite1 / EE2 \$2060
<ul style="list-style-type: none"> • Planar Seat with 1/2" of Soft Sunmate over 1" of Medium • Planar Back with 1" of Soft Sunmate • EZ-Lite Seat Mount Hardware • EE2 Back Mount Hardware • EE5A (Straight) or EE5B (Offset) Fixed Trunk Laterals with 5" Track & Flat Pads • Flip and Fold Seat to Back Bracket  | <input type="radio"/> FD Model 40 - EZ-Lite1 / EE2 \$2682
<ul style="list-style-type: none"> • Mod-1Y Contour Seat with 1/2" of Soft Sunmate over 1" of Medium • Mod-2I Curved Wood Back with 1" of Soft Sunmate • EZ-Lite Seat Mount Hardware • EE2 Back Mount Hardware • EE5A (Straight) or EE5B (Offset) Fixed Trunk Laterals with 5" Track & Flat Pads with Straight Brackets • Flip and Fold Seat to Back Bracket  |
|---|--|

Seat Modification Options

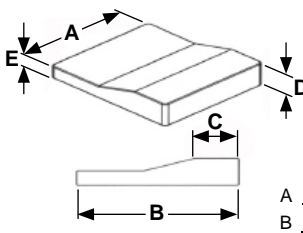
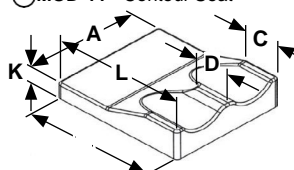
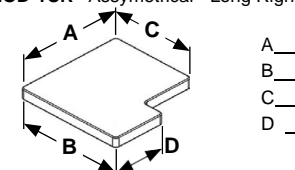
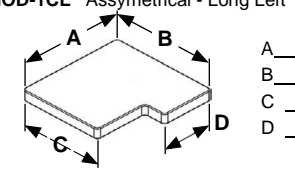
- | | | |
|--|---|---|
| <input type="radio"/> MOD-1K Anti-Thrust Seat \$255

A _____
B _____
C _____
D _____
E _____
Thickness Dimensions On Seats Include Foam <u>Only</u> | <input type="radio"/> MOD-1Y Contour Seat \$394

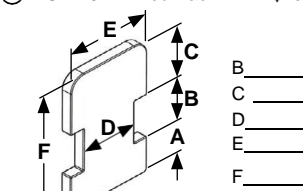
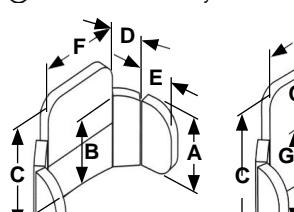
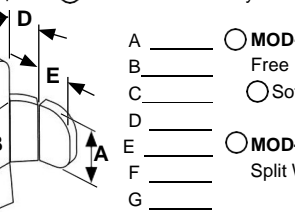
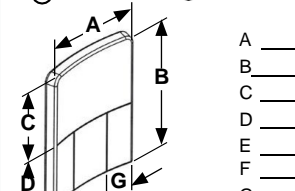
Layer Foam Type Thickness
Top _____
Middle _____
Bottom _____
Thickness Dimensions On Seats Include Foam <u>Only</u> | <input type="radio"/> MOD-1CR Assymetrical - Long Right \$106

A _____
B _____
C _____
D _____ |
| | <input type="radio"/> MOD-1DD Modular Contour Cushion \$432 | <input type="radio"/> MOD-1CL Assymetrical - Long Left \$106

A _____
B _____
C _____
D _____ |



















Back Modification Options

- | | | |
|--|--|---|
| <input type="radio"/> MOD-2H I Mod Back \$155
<input type="radio"/> MOD-2J T Mod Back \$155

B _____
C _____
D _____
E _____
F _____ | <input type="radio"/> 102-12000 Std. Easy Conforming \$1262

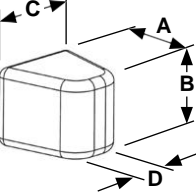
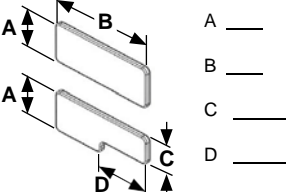
A _____
B _____
C _____
D _____
E _____
F _____
G _____ | <input type="radio"/> 102-13000 Ext. Easy Conforming \$1262

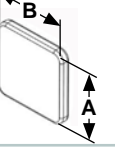
A _____
B _____
C _____
D _____
E _____
F _____
G _____ |
| | <input type="radio"/> MOD-2S \$313
Free Form
<input type="radio"/> Soft <input type="radio"/> Medium | <input type="radio"/> MOD-2GG \$510
<input type="radio"/> Curved Foam <input type="radio"/> Curved Wood

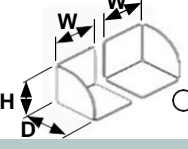
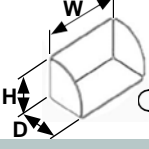
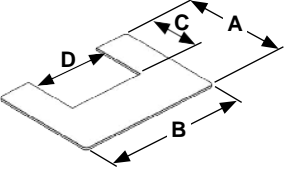
A _____
B _____
C _____
D _____
E _____
F _____
G _____ |

Freedom Designs – Seating & Positioning Order Form Version 1

Buyer: _____
 Co./Account: _____
 Location: _____
 Contact #: _____

P.O. #: _____
 Marked For: _____
 Fax: _____
 Email: _____

Headrests - Ala Carte					Anterior Posture Supports									
 <input type="radio"/> 7700 \$174 Vert. & Horz. Adj.	 <input type="radio"/> 7701 \$367 Multi-Adjustable	 <input type="radio"/> 7703 \$395 Ball & Socket	 <input type="radio"/> 7704 \$366 Removable	 <input type="radio"/> 7708 \$475 Rock & Roll	 <input type="radio"/> 7709 \$486 Flip Down	 <input type="radio"/> EE6V \$198	 <input type="radio"/> EE6S \$198	<input type="radio"/> Dynamic <input type="radio"/> Static						
 <input type="radio"/> 7753 \$380 3 Piece Hinged <input type="radio"/> S <input type="radio"/> M <input type="radio"/> L	 <input type="radio"/> 7756 \$227 Chubbie <input type="radio"/> S <input type="radio"/> M <input type="radio"/> L	 <input type="radio"/> 7756-Bell \$271 Chubbie Bell <input type="radio"/> S <input type="radio"/> M <input type="radio"/> L	 <input type="radio"/> 7757 \$180 Low Profile <input type="radio"/> S <input type="radio"/> M <input type="radio"/> L	 <input type="radio"/> 7760 \$227 Skinny <input type="radio"/> S <input type="radio"/> M <input type="radio"/> L	 <input type="radio"/> EE6R \$198	 <input type="radio"/> EE6U \$198	<input type="radio"/> XXSmall <input type="radio"/> XSmall <input type="radio"/> Small <input type="radio"/> Medium <input type="radio"/> Large <input type="radio"/> XLarge							
Medial Thigh Support					Lateral Thigh Supports									
 <p>Standard Sizes</p> <p>A _____ <input type="radio"/> Small 3L x 3H x 3-2 Taper B _____ <input type="radio"/> Medium 4L x 3H x 3-2 Taper C _____ <input type="radio"/> Large 5L x 4H x 4-2 Taper D _____ <input type="radio"/> X-Large 6L x 5H x 5-3 Taper</p> <p>Pad / Hardware Included</p>					 <p>A _____ <input type="radio"/> Straight <input type="radio"/> 1" Offset <input type="radio"/> Contour Pad <input type="radio"/> 2" Offset <input type="radio"/> Reverse <input type="radio"/> Best fit</p> <p>B _____ C _____ D _____</p>									
<input type="radio"/> EE3A \$297 Adjust Remove	<input type="radio"/> EE3B-2 \$510 Flip / Adjust	<input type="radio"/> EE3E \$510 Flip / Adjust	<input type="radio"/> EE3P \$510 Flip Down	<input type="radio"/> MOD-4A \$110 Custom Contour	<input type="radio"/> EE4A/B \$287 L-Bracket (pr)	<input type="radio"/> EE4C \$573 Quick Release (pr)	<input type="radio"/> EE4D \$519 Knee Adductor	<input type="radio"/> Small <input type="radio"/> Medium <input type="radio"/> Large						
Trunk Supports														
 <p>A _____ <input type="radio"/> Standard <input type="radio"/> Thin B _____ <input type="radio"/> Flat <input type="radio"/> Curved <input type="radio"/> 4L x 3H <input type="radio"/> Sunmate <input type="radio"/> T-Foam <input type="radio"/> 5L x 4H <input type="radio"/> 6L x 5H</p>					<input type="radio"/> MOD-5F \$64 Fabric Sleeve Boot					<input type="radio"/> EE5I Tracks \$64/pr <input type="radio"/> 3" Single <input type="radio"/> 11" Single <input type="radio"/> 5" Single <input type="radio"/> 9" Double <input type="radio"/> 7" Single <input type="radio"/> 11" Double <input type="radio"/> 9" Single				
<input type="radio"/> EE5E \$573 Lift / Swing	<input type="radio"/> EE5J \$486 Fixed Summer/Winte	<input type="radio"/> EE5P \$643 Lever/Swing	<input type="radio"/> EE5Q \$808 Lever Summer/Winte	<input type="radio"/> EE5S \$770 Lever Summer/Winter	<input type="radio"/> MOD-5J \$51ea									
Lower Leg and Foot Supports														
 <p>Hi-Tops Static <input type="radio"/> EE9B Dynamic <input type="radio"/> EE9B-D \$135 <input type="radio"/> EE9F <input type="radio"/> EE9F-D \$204 <input type="radio"/> S <input type="radio"/> M <input type="radio"/> L</p>			 <p>Shoe Holders \$201 <input type="radio"/> EE9 Velcro <input type="radio"/> EE9C Buckle <input type="radio"/> S <input type="radio"/> M <input type="radio"/> L</p>			 <p><input type="radio"/> 08-10000 \$728 Leg Cradles</p>			 <p><input type="radio"/> 08-11000 \$623 Foot Box</p>					
Trays														
 <p>A _____ B _____ C _____ D _____</p>					<input type="radio"/> 08-8000 Lexan Tray - No Hardware \$193 <input type="radio"/> 08-6000 Lexan Tray - Adj. Knob Release/ Ribs \$265 <input type="radio"/> 08-12000 EZ-Lite Lexan Tray - 1/4" Thick \$206 <input type="radio"/> 08-13000 EZ-Lite Lexan Tray with Ribs \$221 <input type="radio"/> 08-15000 Lexan Tray / 1" Locking Hooks \$244					<input type="radio"/> 08-17000 1/4" Lexan Tray w/o Hardware \$115 <input type="radio"/> MOD-8J Stability Belt \$48 ea. <input type="radio"/> MOD-8K Elbow Blocks \$287 pr. <input type="radio"/> 454A Knob Release \$63 ea. <input type="radio"/> 454B Toggle Release \$199 ea. <input type="radio"/> 461 Channel Bracket \$80 ea.				

FREEDOM DESIGNS, INC. 2241 N. Madera Rd. Simi Valley, CA. 93065 800-331-8551 Fax 888-582-1509