



FREEDOM DESIGNS, INC.

Seating & Positioning Catalog

Temporary Update April, 2016



We at Freedom Designs, Incorporated, have been involved in manufacturing seating systems and components since 1982. We have an ongoing commitment to quality of product, customer service, delivery time and representation. The vision of excellence extends throughout every phase of order, production and delivery, to ensure you and the end user of the finest product available.

We have a strong commitment to being the leader in the field. We are guided by the needs of the marketplace, by you, the Rehab Technology Specialist and Therapists. Our unique products are the result of input by industry professionals and our engineering team consisting of a mechanical engineer and an aerospace engineer. With this perspective, and an in-house machine shop, we are able to design the most functional, durable and cost effective products. With our computerized design capability, we continue to develop better parts, while realizing manufacturing economies, which we can pass along to you.

Our Pursuit of excellence also extends to supporting our dealers and therapists. We are involved in an education program offering CEUs (Continuing Education Units), as well as ongoing training in a field that is rapidly changing.

Our vast line of products, plus our ability to do custom orders, offers state-of-the-art solutions to your difficult seating problems. We thank you, our customers, for your support in the past and look forward to continuing to serve you.

Freedom Designs, Inc.



INTRODUCTION

<i>Business Procedures and Policies</i>	2
---	---

SEATING COMPONENTS

<i>Solid Seats</i>	3
<i>Seat Modifications</i>	11
<i>Solid Backs</i>	20
<i>Back Modifications</i>	30
<i>Medial Thigh & Anterior Pelvic Supports</i>	39
<i>Lateral Pelvic / Thigh Supports</i>	48
<i>Lateral Thoracic & Posterior Lumbar Supports</i>	53
<i>Anterior Trunk & Anterior Shoulder Supports</i>	65
<i>Posterior, Anterior & Lateral Head Supports</i>	74
<i>Extremity Supports</i>	88
<i>Trays</i>	98
<i>Auxiliary Device Holders</i>	105
<i>Accessories</i>	107
<i>Cushions</i>	109
<i>Upholstery Fabric Descriptions</i>	113
<i>Upholstery Fabric Color Choices</i>	114

HARDWARE	116
-----------------------	-----

<i>Cushion Packages</i>	154
-------------------------------	-----



Dealer Accounts & Terms

A Freedom Designs, Inc. dealer application must be completed and approved before an account can be established. Freedom Designs standard terms for open accounts are net 30 days, unless other terms are agreed upon. Completed orders will not be shipped and new orders will not be processed on accounts with outstanding balances over 60 days.

Ordering

Orders may be placed over the telephone, faxed, mailed or e-mailed into the Customer Service Department. Measurement forms are provided in the catalog to assist in ordering. Phone orders must be followed up with a hard copy confirming P.O. For any questions, please call Customer Service.

Published Prices

Prices are subject to change without prior notice.

Price Quotes

If requested, customer service will provide a written quote on products. Written quotes will be valid for 60 days.

Shipping

All Freedom Designs, Inc. products are shipped ground, FOB Simi Valley. Freight charges on factory installs may apply on wheelchairs not manufactured by Freedom Designs, Inc. For requests of special handling or exceptional freight, up-charges will be billed.

Returns

All returns must have a Return Authorization Number on the box and must be shipped freight pre-paid. Product received without a valid R.A. # will be refused. The R.A. # must be obtained from the Customer Service Department. All returns MUST be received in the factory within 45 days of issuance of the R.A. #. Returns are subject to examination at the discretion of Freedom Designs, Inc. Returns may be subject to a 25% restocking fee. Custom fabricated products may not be returned.

Cancellations

Prior to canceling an order, a valid cancellation number must be obtained from Freedom Designs Customer Service Department. Restocking charges will occur on orders in progress and will be assessed based on the stage of completion. Custom fabricated products will be charged at 100%.

Errors & Omissions

All Freedom Designs products are quality controlled prior to shipping. However, should there be a problem, it must be reported to Customer Service within three weeks of receipt of order for resolution.

Liability

Freedom Designs, Inc. is not responsible for any product used incorrectly or with the wrong application. We recommend that positioning products be used in conjunction with a team of professionals that have been involved with the evaluation of the client. Freedom Designs, Inc. is responsible for any product that is defective in manufacturing or that was made in error by Freedom Designs, Inc.

Limited Warranty

Hardware—Lifetime Warranty
Foam, wood and workmanship—1 year
Any product found to be defective due to the material or workmanship within one year, will be replaced under our return policy, once Freedom Designs, Inc. has evaluated the product. This replacement warranty does not include misuse of the product. For further information please contact our Customer Service Dept. at 800-331-8551.

Hours of Business

Customer Service: Monday through Friday
6:00 a.m. to 5:00 p.m. PST
Message Center: Available when factory is closed
FAX Line: Open 24 hours a day,
7 days a week

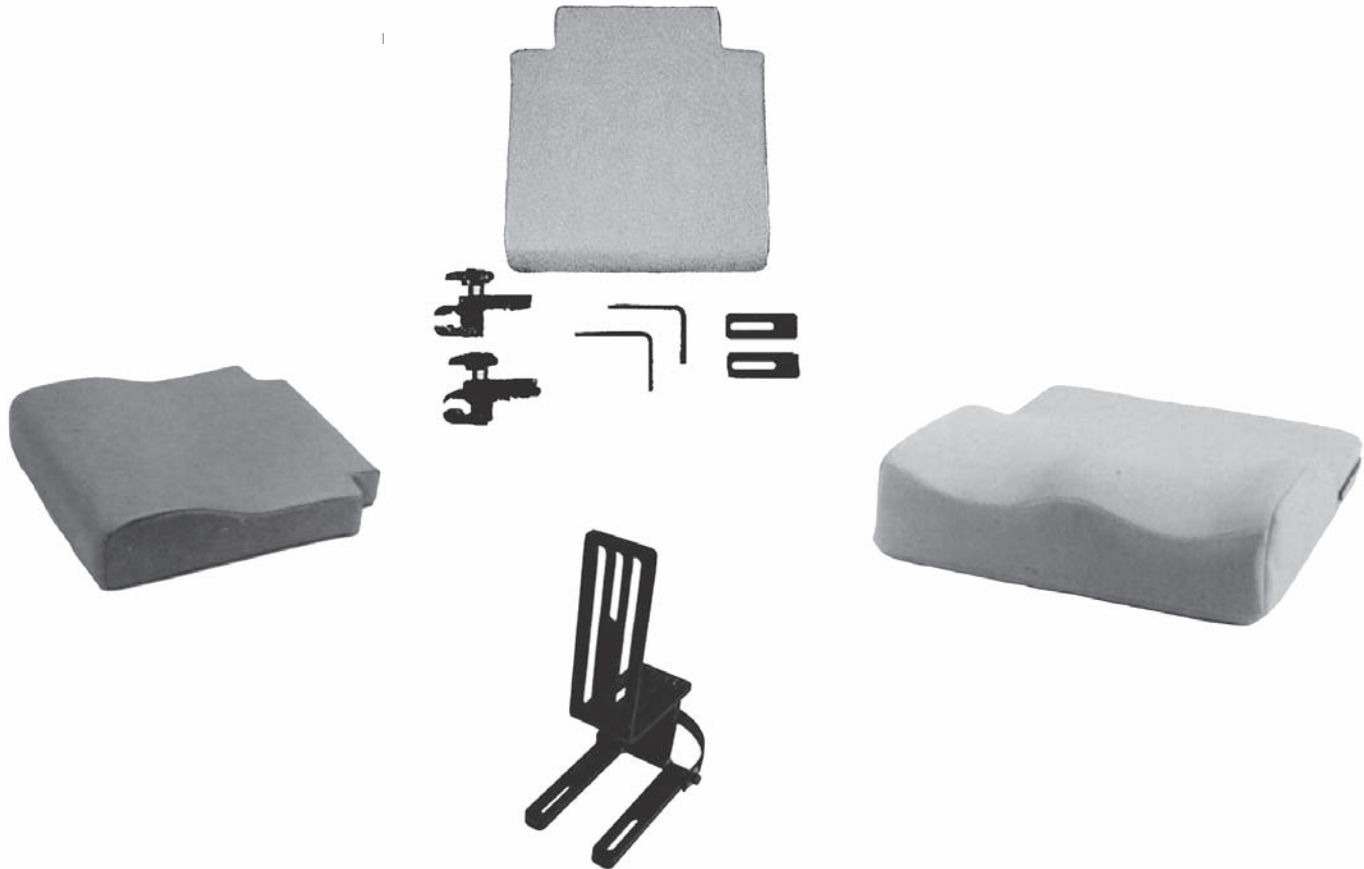

All solid seats are constructed of 1/2" marine grade plywood with 1-1/2" high density 4# foam and your choice of fabric. Seats ordered with Freedom Designs, Inc. mounting hardware will be T-nutted for that hardware as well as any Freedom Designs, Inc. inserts ordered or specified at point of order, at no charge. Solid seat inserts ordered without hardware will be T-nutted per your instructions, this includes T-nuts for other manufacturers. (See Mod-1Q for charges). All solid seats come with a zipper closure. All solid seats that are cut full width will come with standard 2" wide x 2" deep notches unless otherwise specified.



Seat & Back Combinations

Freedom Designs, Inc. offers a series of seats & backs designed to be hinged together. All seat & back combinations are quick release for ease of transport. All seats come with standard Freedom Designs, Inc. construction. Seats in this series are cut full width unless otherwise specified. As with all full width seats, 2" wide x 2" deep notches come standard.

If you mix and match the seats and backs in this series, you will receive the hinge at no additional charge. These seats can not be mounted independently without additional hardware. (Hinges are not included when ordering seat or back only).

EE1 Solid Seat with ECONO-EZE Hardware

Standard solid seat with (2) each #439 ECONO-EZE Seat Brackets, (2) each #462 EE Frame Clamps and (2) each #436 ECONO-EZE 30° clamps. This hardware is designed to mount to 1", 7/8" or 3/4" round tubing.

EE1-LT Solid Seat with ECONO-EZE Lite

No Longer Available

Standard solid seat with (2) each #439B ECONO-EZE Lite Seat Brackets, (2) each #462 EE Frame Clamps and (2) each #436 ECONO-EZE Lite 30° clamps. This hardware is designed to mount to 1", 7/8" or 3/4" round tubing.

EE1 Solid Seat—No Hardware

Standard solid seat without hardware

EE1-Micro Solid Seat with Micro Hardware

(Only available on seating systems of 14" wide and under)

Standard solid seat with (2) each #439A EE Micro Seat Brackets, (2) each #462G EE Micro Frame Clamps and (2) each #436 30° Clamps. This hardware is designed to mount to 1", 7/8" or 3/4" round tubing.

EE1-PK1 Econo Eze Seat Base with Adjustable

Package consists of a solid seat base with no padding and with hook and loop on top to secure a cushion. Seat is mounted with (2) each #462A Econo Eze frame clamps., (2) each #439 Econo Eze seat mount brackets, (2) each # 504 EZ-Lite seat clamps and seat to back brackets.

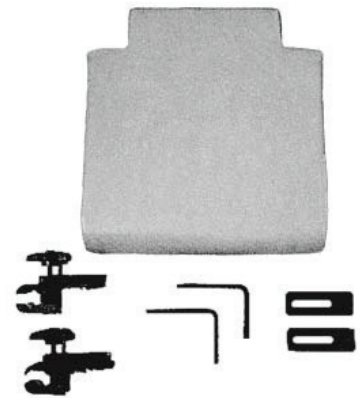



Easy Clamp 1

Standard solid seat with (2) each #567 Easy Clamp Brackets, (2) each #403A Split Collars and (2) #436 30° Clamps. This hardware is designed to mount to 1" round tubing.



EZ-Lite1 Solid Seat with EZ-Lite Hardware

Standard solid seat with (2) each #504A-B frame clamps and (2) each #436 30° clamps. This seat can only be cut full width and has no ability to be angle adjustable. Mounts flat on top of the seat rail. Clamps fit 1" round tubing only. 3" growth can be added to this seat. Seats are cut full width with 2" wide x 2" deep back post notches, unless otherwise specified.



EZ-Lite1 EXT Solid Seat / Extended EZ-Lite Clamps

Same as above with 2" long EZ-Lite clamps.



TWIST1 Solid Seat with Twister Hardware

Standard solid seat with (2) each #494 frame clamps and (2) each #436 30° clamps. These clamps will fit 1", 7/8" or 3/4" round tubing. This hardware allows changes in the seat to back angle and when used with EE2 or TWIST2 back, will allow the system to be tilted within the chair frame. 3" growth can be added. Seats are cut full width with 2" wide x 2" deep notches, unless otherwise specified.



Snap-Lock1 Solid Seat with Snap-Lock Hardware

Standard solid seat with (2) each #494A, B or C Snap-Lock frame clamps and (2) #436 30° clamps.



Glide1 Solid Seat with Glide Lock Hardware

Standard solid seat with (2) each #520 Glide Lock frame clamps, (2) each #436 30° clamps and (2) sets #415A J/L's.





Locking DH1 Solid Seat with 2 Locking Drop Hooks

Standard solid seat with (2) each #553 locking drop hooks and (2) each #426 30° clamps. The locking drop hooks fit 1" diameter tubing only. This hardware positively secures the seat while allowing for quick removal from the frame.



101-1000 Seat Insert

Standard solid seat insert designed to be used on a sling seat. No accommodation is made to this solid seat insert for attaching to the chair. Seats are cut to your specifications.

If tabs and snaps or hook and loop are necessary, please specify.

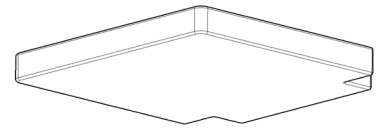

For additional cushion packages, please see page 156 in the hardware section of this catalog.

101-1000A Solid Seat Insert with T-nuts

Standard solid seat comes with one set of T-nuts. When ordering this seat, you will receive all Freedom Designs, Inc. T-nuts specified. You may also order T-nuts for one manufacturer's components at no charge. Additional T-nuts for various components (not Freedom Designs, Inc.) or other manufacturers, will result in additional charges. (See Mod-1Q) for charges. Seats are cut to your specifications. If tabs and snaps or hook and loop are necessary, please specify.

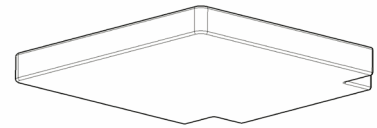

101-2000 Solid Seat with 1" Drop Hooks

Standard solid seat with (4) each #405A1 1" drop hooks and (4) each #426 30° clamps. Designed to allow easy folding of backposts while the seat stays attached to the frame (when cut between the rails). Seats are cut to fit between the rails unless otherwise specified. Seat can be ordered full width, with 2: wide x 2" deep notches. If seat is cut between rails, chair info is necessary for x-brace cut-outs. Stainless steel drop hooks are available at no extra charge, upon request.



101-3000 Solid Seat with 1", 2" or 3" Drop Hooks

Standard solid seat with (4) each of your choice of either #405A1 1" drop hooks, #406A1 2" drop hooks or #407A1 3" drop hooks and (4) each split collar clamps. This hardware is designed to fit 1", 5/8" or 3/4" round tubing. Hardware allows you to order the seat with a specific amount of drop dependent on your client's needs. Seat must be cut to fit between the rails. Wheelchair information is required in order to cut x-brace cut-outs and for tube size. Stainless steel drop hooks are available at no extra charge, upon request.

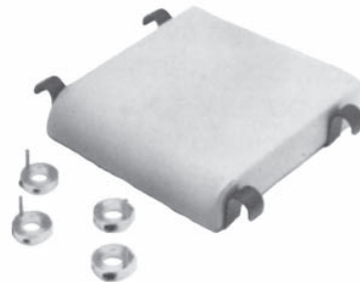

101-4000 Solid Seat with J & L Brackets and Split Collar Clamps

Standard solid seat with (4) each #413A L-brackets, (4) each #414 J hooks and (4) each #402 split collar clamps. This hardware will allow up to 3" of drop or 2" of elevation from the seat rail. The design also allows for seat to back angle adjustment. Seat will be permanently mounted and cannot be removed without tools. Seats are cut to fit between the rails unless otherwise specified. Can be ordered full width with 2" wide x 2" deep notches, unless otherwise specified. Wheelchair information is required in order to cut x-brace cut-outs. Tubing size must also be specified. Stainless steel brackets, extended L's and crescent l's for adjustability are available upon request.



101-5000 Solid Seat with L-Brackets Pg. 1 price booklet

Standard solid seat with (2) pair of #413A L-brackets. This combination of hardware is designed to mount on many of the chair frames that have non-round rails. Angle adjustable double L-brackets bolt directly to the frame rail in the manufacturer's pre-drilled tubing or tracked rails. Double L-brackets are sent, although you may find single L-brackets will be sufficient, depending on frame tube styles. Seats are cut to fit between the rails unless otherwise specified. Stainless steel L-brackets are available at no extra charge, upon request.





101-6000 Solid Seat with Snaplock

Standard solid seat with (4) each #490 Snaplock frame clamps. This light weight snap-in hardware is perfect when a full width seat is needed to mount directly on the seat rails and does not require adjustment angle. The hardware is designed to fit 1", 7/8" or 3/4" round tubing and cannot be mounted on folding chairs with separate side frame and seat rails.



101-7000 Solid Seat with J & L Brackets and Quick Release Brackets

Standard solid seat with (4) each #492 L-brackets, (4) each #414A J-hooks and (4) each #457 quick release frame clamps. 1", 7/8" or 3/4" drop hooks are available at no extra charge. The light weight, lever release clamp is designed to fit 1", 7/8" or 3/4" round tubing. The adjustable J & L brackets allow change in seat to back angle and with the matching back hardware (102-7000), can allow you to tilt the system within the chair frame. Seats are cut to fit between the rails, unless otherwise specified. Can be ordered full width with 2" wide x 2" deep notches. Stainless steel J & L's are available at no charge, upon request.

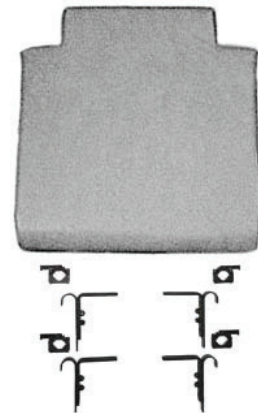

101-7500 Solid Seat with ECONO_EZE Hardware

Standard solid seat with (4) each #462 ECONO-EZE frame clamps and (4) #439 seat mounting brackets..

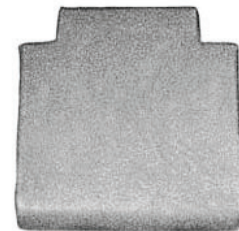

101-7500-LT Solid Seat / ECONO-EZE LITE Hardware

Same configuration as the 101-7500 with the (2) pair of #462A replaced by #439B ECONO-EZE LITE seat mount brackets

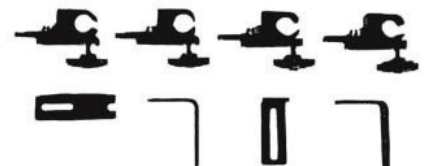

No Longer Available



101-9000 Solid Seat with Twister Hardware

Standard solid seat with (4) each #494 Twister frame clamps and (4) each # 413A L-brackets. This hardware is designed to mount to 1", 7/8 or 3/4" round tubing. Along with clamps that totally remove from the frame, you get L-brackets that allow for seat drop, seat elevation and angle adjustment. Stainless steel L's, crescent L's and extended L's are available. Seats are cut to fit between the rails, unless otherwise specified. Seat can be ordered full width with 2" wide x 2" deep notches. Wheelchair information is required in order to cut x-brace cut-outs and for tubing size.



101-10000 Solid Seat with 4 EZ Lite Clamps

Standard solid seat with (4) each #504A EZ Lite clamps. The EZ Lite clamps are designed to fit over 1" diameter tubing.

101-10000-EXT Solid Seat with 4 EZ Lite Extended Clamps

Standard solid seat with (2) pair of #504A EZ Lite Extended clamps. The EZ Lite clamps are designed to fit over 1" diameter tube.



101-11000 Solid Seat with 4 Glide Lock Clamps

Standard solid seat with (4) of #520 Glide Lock Clamps and (4) #415 J & L hooks. This hardware is designed to fit either 1" or 7/8" diameter frame tubing. The adjustable crescent J & L brackets allow change in seat to back angle and with the matching back hardware (102-7000), can allow you to tilt the system within the chair frame. Seats are cut to fit between the rails, unless otherwise specified. Can be ordered full width with 2" wide x 2" deep notches. Stainless steel j & L's are available at no extra charge, upon request.





101-12000 Solid Seat with 2 Pair of EE MICRO
(Only available on seating systems of 14" wide & Under)

Standard solid seat with (4) each #439A EE Micro Sat Brackets and (4) each #462G EE Micro Frame Clamps. This hardware is designed to mount to 1", 7/8" or 3/4" round tubing.



101-13000 Solid Seat with 2 Glide Locks & Split Collars

Standard solid seat with (2) each #520 Glide Lock clamps, (4) #425 J & L hooks and (2) #403 split collar clamps. This hardware is designed to fit 1" and 7/8" round tubing. The adjustable J & L brackets allow change in seat to back angle and with the matching back hardware (102-7000), can allow you to tilt the system within the chair frame. Seats are cut to fit between the rails, unless otherwise specified. Can be ordered full width with 2" side x 2" deep notches. Stainless steel J & L's are available at no charge, upon request.



101-14000 Solid Seat with 4 Locking Drop Hooks

Standard solid seat with (4) each #553 Locking Drop Hooks. This hardware is designed to mount to 1" round tubing. Along with clamps that totally remove from the frame, you get L-brackets that allow for seat drop, seat elevation and angle adjustment.



101-EASY CLAMP

Standard solid seat with (4) each #567 Easy Clamp brackets and (2) each #403A Split Collar clamps. This hardware is designed to mount to 1" round tubing.





Mod-1A Phenolic Base

Phenolic is used instead of the plywood base. It is a dense space-age plastic, 3/8" thick. Phenolic should be used when the client has extreme extensor tone or where client weight is a concern. When phenolic is used on a seat, the cushion is sent separate. If you would like the cushion and phenolic covered as one unit, please specify.

Mod-1B Cut Outs, Foam-Wood-Upholstery

This modification will allow you to remove wood, foam and fabric from a specific area of the seat. Additional charge each time a layer is removed. Please specify cover information in regard to the cut-out.

Mod-1CL (Left) Asymmetrical Seat Front Mod-1CR (Right)

This modification is designed to accommodate those clients that have a leg length discrepancy when seated, of 1 1/2" or more. Please provide dimensions. If an abductor is used on the seat, please specify which side of the asymmetrical cut the abductor should be mounted. If not specified, the abductor mount will be on the short leg.

Front of Seat

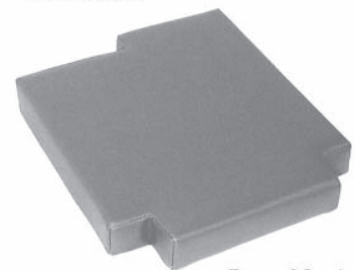

Rear of Seat

Mod-1E Wedge Cut Foam

This modification is designed to accommodate a pelvic obliquity (wedge is lateral) or to provide hip flexion with foam (wedge is anterior/posterior). Please specify direction of wedge and foam thickness.



Mod-1G Cushion Separate from Wood

With this modification, you can remove the seat foam from the wood base, allowing you to replace, change or clean the cover with ease. The cushion will have a zippered cover that attaches to the wood base with hook and loop strips.



Mod-1H Tabs and Snaps

For use when you need to attach a solid seat insert or cushion to the frame of the wheelchair and you are not using hardware. Sling upholstery must be present.

Mod-1I Incontinent Liner

Use this modification to protect the foam from moisture/urine. A thin film encloses both the wood and the foam under the cover.



Mod-1J Laterally Split Seat

This modification divides the seat into front and rear sections and divides the front section laterally for each leg.

Independently hinged and adjustable anterior sections allows you to manipulate the amount of hip flexion required for each leg. For flexion greater than 90°, the anterior section should be cut to fit between the seat rails or the seat must be elevated. Please specify all dimensions of each section. Adjustable bracket hardware is recommended.



Mod-1K Anti-Thrust Seat Foam

This modification provides an anterior rise to the seat. Anti-thrust helps to maintain ischial placement and pelvic positioning in the chair. Standard sizes are available based on client seat depth. Custom anti-thrust is made to your specification on top of foam at no additional charge. The anti-thrust is made with 4# foam unless otherwise specified.

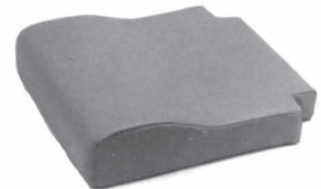



Mod-1L Grid Seat Foam

This modification changes the standard thickness of 4# foam to 2". The foam is then cut into blocks 2" wide X 3" deep and attached to the seat base with hook & loop. The hook & loop allows for removal, carving or replacement of the standard foam with custom foam as needed. The cover comes in two pieces and the face cover is completely removable for total access to the foam. The removable face cover also allows for easy cleaning.

*Custom sizing for the blocks is available
(See Mod-1U for cover only up-charge)*

- Mod-1L1** 9 Additional Foam Blocks in 3#, 4# or 5# Foam, please specify
- Mod-1L2** 9 Additional Foam Blocks in X-Soft, Soft, Medium and Firm T-Foam, please specify.
- Mod-1L2A** 9 Additional Foam Blocks in Soft, Medium and Firm Sunmate, please specify.
- Mod-1L3** 9 Additional Foam Blocks in Pudgee Foam

*Additional foam blocks are 2" thick.
Charges will apply for additional thickness.
(See custom foam pricing and apply charges from trunk/hip).*

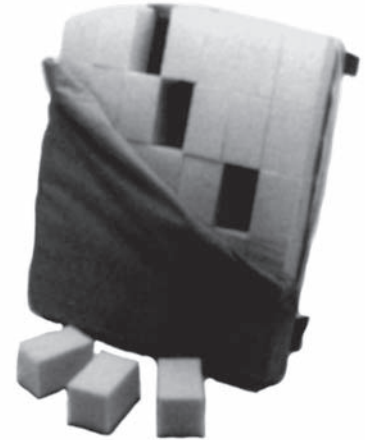

Mod-1M Two-Tone Upholstery

This modification is used when multiple fabrics or colors are used on the seating surface. Two-tone fabric is quilted to reduce the opportunity for skin breakdown, due to seams and hard surfaces. There is no up-charge for multiple colors/fabrics on separate surfaces.



Mod-1N Monogram Client's Name

This modification is provided free of charge when you order a system (both a seat and a back with hardware on the same order). The free monogram can be up to 18 letters and we can match most frame colors on the market today. The available letter styles are pictured here. (See Mod-1T for monogram charges when a system is not ordered).

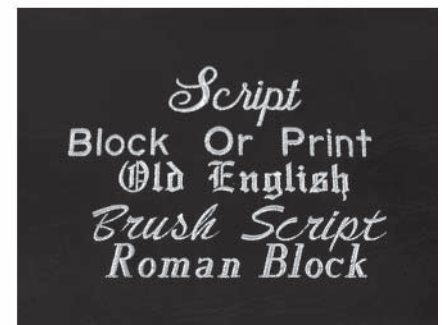



Mod-1O Back Post Notches

All full width seats will automatically receive notches 2" wide x 2" deep, unless otherwise specified. Notches provide for maximum growth potential on pediatric seating systems.

Mod-1P Hook & Loop Strips

Hook or loop strips can be added to the seat to attach a solid seat to a seat sling or seat pan or to attach a cushion to a Freedom Designs, Inc. seat base. Please specify chair make and model or cushion manufacturer.



Mod-1Q T-nuts

T-nuts can be added to any solid seat being made. Please specify mounting hardware, i.e. (101-4000), or components manufacturer model number, or provide a diagram of t-nut placement. Charges are one time for all Freedom Designs, Inc. t-nuts needed or for all t-nuts for each individual manufacturer's components.

Mod-1R Standard Seat Cover

This cover is designed to fit a Freedom Designs, Inc. standard seat and to be closed with staples. You must provide dimensions or original order information. Cover can be made to fit anti-thrust or other custom seats when diagram is provided. A zipper closure is available at no additional charge upon request.

Mod-1RC Custom Seat Cover Only

This cover is for a very custom contoured or carved seat. You must provide dimensions or original order information. Zipper closure is standard. For best results, the cover should be made of a stretch fabric.

Mod-1R2 Contour Seat Cover with Zipper

This cover is designed to fit a Freedom Designs, Inc. contoured or anti thrust seat. You must provide dimensions or original order information. A zipper closure is standard. For best results, the cover should be made of a stretch fabric.



Mod-1S Free Form Seat

The Free Form modification is foam-in-place seating. This molding system is designed to interface with all Freedom Designs, Inc. positioning components. This system provides the capability to mold the most difficult client, with fixed deformities and still provide aggressive positioning with medial and lateral thigh supports, sub A.S.I.S. bars, etc. Each kit contains Sunmate chemicals, gloves, safety goggles, bag and bucket for mixing. The solid seat will come with 1" foam of your choice (except pudge) to prevent bottoming out of client. The cover has 1/4" Sunmate foam sewn inside of the contact surface for added comfort. For best results, the cover should be made of stretch fabric.



Mod-1S1 Free Form Chemicals Only

This modification will give you the liquid Sunmate chemicals, pour bag and mixing bucket. This is what you need if you already have the back and cover and need to re-pour or if you need extra chemicals.

Mod-1S2 Lateral Blocker Kit

This is a one-time purchase by the dealer. Lateral blockers help keep the foam from expanding on the sides of the seat and direct the foam towards the client.

Mod-1S3 Free Form Cover

Use this modification when you are ordering a seat and only need the cover to complete the Free Form pour. The cover will have bi-lateral zippers on the top edges of the seat. The cover has 1/4" Sunmate sewn inside of the contact surface for added comfort. For best results, the cover should be made of stretch fabric.

Mod-1S3A Free Form Cover Only

Use this modification when a cover is all you are ordering. The cover has 1/4" Sunmate foam sewn inside of the contact surface for added comfort. The cover will have bi-lateral zippers at the top of the back. For best results, the cover should be made of a stretch fabric.

Please give exact dimensions for cover. Width x Depth x Thickness



Mod-1S4 Internal Lateral Supports

These lateral supports are designed to mount under the cover of a Free Form Seat. Mounting with narrow L-brackets, the perforated wood bases allows the foam to surround the wood base. ABS is available, please specify. This gives a rigid lateral support that will allow firm positioning regardless of tone. The top and side edges of the wood base have padding for protection and comfort. Please specify the size you need: L x H



Mod-1T Monograms (No system ordered)

Use this modification when you would like a monogram and have not met the criteria for a free monogram. See Mod-1N for specifics on how to qualify for a free monogram.

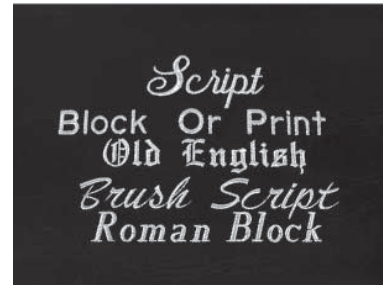

Mod-1U Removable Grid Style Cover

Use this modification when you are ordering a seat and wish to incorporate a removable cover on the seat or an extra face cover when a grid is ordered. This removable face cover allows for easy cleaning.

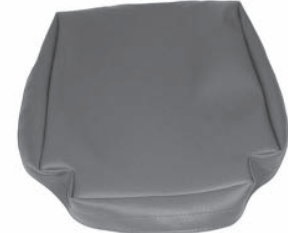

Mod-1U1 Removable Grid Style Cover (No seat ordered)

Use this modification when you are only ordering the cover and no seat is ordered. Please specify face cover only, bottom cover only or complete set. Charges double when ordering a set. Please provide all dimensions or original order information: width x depth x thickness and notch sizes, if applicable.



Mod-1V Contour Seat Foam Abductor and Anti-Thrust

This modification will give you an abductor build up and anti-thrust ledge. Standard sizes are based on client seat depth or you can specify all dimensions. Anti-thrust is standard on all contours, unless otherwise specified.





Mod-1W Contour Seat Foam Adductors and Anti-Thrust

This modification gives you adductor build ups and anti-thrust ledge. Standard sizes are based on client seat depth or you can specify all dimensions. Anti-thrust is standard on all contours, unless otherwise specified.



Mod-1X Checker Board Cut Foam

This modification takes the standard 1 1/2" 4# foam and cuts it partially into 1' wide x 1" deep blocks. This breaks up the resistance of the foam for patient comfort. Blocks are not removable. For best results when checker boarding, a stretch cover is suggested. Custom foams are available in any thickness, please specify.



Mod-1Y Contour Seat Foam Adductors, Abductor and Anti-Thrust

This modification will give the seat adductor and abductor build-ups and an anti-thrust ledge. Standard sizes are based on client seat depth or you can specify all dimensions. Anti-thrust is standard on all contours, unless otherwise specified.

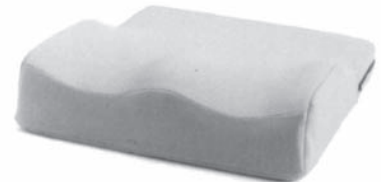

Mod-1Z Cushion Base

Use this modification when you need to modify your seat to accept a cushion. This base provides a phenolic base with three ABS sides and a surface completely covered in hook / loop to help secure the cushion to the base. Sizing is based on chair width and cushion depth.

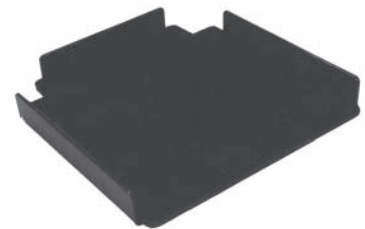

Mod-1AA Embroidery Design

Freedom Designs, Inc. offers a limited number of designs that can be embroidered on your seat. Please contact the Customer Service Department to discuss the available designs. Pricing is based on the number of stitches required to make the design

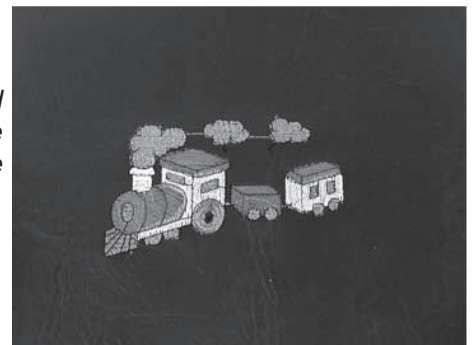



Mod-1BB I-Mod on Seat

Solid seats are cut into the shape of a capital I. This cut will allow hip guides to be mounted close to the client. When you choose this modification, you must provide the dimensions for the I-modification. There are no standard sizes for I-modifications.

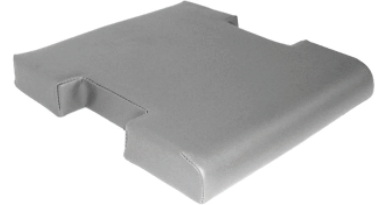

Mod-1CC Zipper Closure

Use this modification when you wish to add a zipper closure to the rear of the seat. All contour seats come with a zipper closure automatically. A zipper closure is a no-charge option.

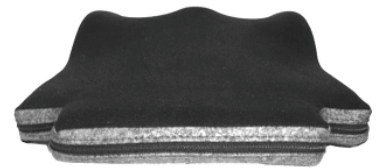

Mod-1DD Modular Seat Contour Cushion

This Modular Seat Cushion is a modification to any of our solid seats. This modification comes with multiple Ethafoam blocks with velcro in various sizes for abductor, anti-thrust and adductor build ups. These blocks velcro to the wood. The Ethafoam blocks can be cut to desired shapes in the field. The anti-thrust is cut into sections to allow repositioning of the ischial shelf after growth of client. Covering the Ethafoam blocks is one layer of 1/2" Sunmate foam and 1/2" 4# foam. The whole seat is enclosed with a zipper stretch cover. Great for modification of a seat in the field.



Mod-1DD1 Modular Contour Cushion Kit—Adductor/Abductor

Mod-1DD2 Modular Contour Cushion Kit—10 x 10

Mod-1EE Foam - Full Width Wood Between Rails

Mod-1FF Removable Incontinent Slip Cover



Mod-1GG Track Mount Hardware—Single



**Mod-1HH Flip and Fold Seat to Back Hinge Bracket
Substitute 430 or 430A**

This seat to back hinge allows extreme depth and height adjustment of the back in relationship to the seat. There is a “hold handle” in the rear made of webbing for ease of removal and storage.



Mod –1II 1/4” Thick Applewood

The base wood of the seat is 1/4” instead of 1/2”. For 14” and under systems only. Cannot be curved

Mod-1KK Omit Wood

Mod-1LL Easy Conforming Adjustable Anti-Thrust

This modification allows for custom adjustment of the anti-thrust build-up in the seat cushion. Seat is made up of individual panels and locking hinges.



Mod-1MM Easy Conforming Adjustable Contour

This modification allows for custom adjustment of the anti-thrust , adductors and abductor contours in the seat cushion.



Mod-1NN Easy Conforming Adjustable Anti-Thrust & Adductors

This modification allows for custom adjustment of the anti-thrust & adductor contours in the seat cushion.



Mod-1OO Easy Conforming Adjustable Adductors

This modification allows for custom adjustment of the adductor contours in the seat cushion.





The Standard Solid Back

All solid backs are constructed of 1/2" marine grade plywood with 1" of medium density 3# foam and your choice of any fabric. Backs ordered with Freedom Designs, Inc. mounting hardware will be t-nutted for that hardware, as well as any Freedom Designs, Inc. component ordered or specified at the time of order at no charge. Solid back inserts ordered without hardware will be t-nutted per your instructions; this includes t-nuts for other manufacturers. (See Mod-2Q for charges.) A zipper closure is standard on all solid backs.



Seat & Back Combinations

Freedom Designs, Inc. offers a series of seats & backs designed to be hinged together. All seat & back combinations are quick release, for ease of transport. All backs come with standard Freedom Designs, Inc. construction.

EE2 Solid Back with ECONO-EZE Hardware

Standard solid back with (2) each #462 frame clamps and (2) each #437A back mounting forks. Each frame clamp comes with the ability to fit 1", 7/8" or 3/4" round tubing. Special clamps are available to fit most non-round tubing. This hardware allows you to manipulate the seat to back angle and when used with EE1 or TWIST1 seats will allow the system to be tilted within the chair frame. Backs are cut to fit between the back posts, unless otherwise specified.



EE2SL Solid Back with ECONO-EZE Spring Loaded Hardware

Same as above with (2) each #515 spring loaded back mounting forks.



EE2-LT Solid Back with ECONO-EZE LITE Hardware

No Longer Available

Same as EE2 with #437F ECONO-EZE LITE back mounting forks replacing the #437A back mounting forks.

EE2- No Hardware—Solid Back with No Hardware

Same EE2 solid back without mounting hardware.



EE2 Micro Solid Back with Micro Hardware

Same EE2 solid back with Econo-Eze Micro mounting hardware. Only available on seating systems of 14" wide and under.

EE2 Micro-LT Solid Back with Micro Lite Hardware

No Longer Available

Same EE2 Micro solid back with #437G Econo-Eze Micro Lite mounting hardware. Only available on seating systems of 14" wide and under.



No Longer Available

TWIST2 Solid Back with Twister Hardware

Standard solid back with (2) each #494 frame clamps. These clamps will fit 1", 7/8" or 3/4" round tubing. This hardware allows changes in the seat to back angle and with EE1 or TWIST1 seats will allow the system to be tilted within the chair frame. Backs are cut to fit between the back posts, unless otherwise specified.



EZ LITE2 EZ Lite Back

This back is equipped with 2 snap lock clamps and a seat to back hinge

EZ CONF2 Easy Conforming Back—Standard with 2 J/L's, Glide Locks & Hinges

This back allows contouring at the posterior and lateral planes of the trunk and hips. This back has a pre-contoured shape and is constructed of 5 lightweight plastic panels that are connected to each other with adjustable locking hinges. The lateral portions can be independently positioned from a flat position to a 90-degree angle. This back can be order standard based on frame width, or custom ordered with patient measurements. Foam in place is an additional option.



Hardware: (2) crescent L/J brackets, and (2) universal glide lock securement clamps.

(2) seat to back hinges

Foam: 1/2" 3lb base and a 1/2" medium sunmate top layer

Fabric: Only offered with dynamic

T-Nuts: Complete with multiple T-nuts.

EZ CONF2-21W Easy Conforming Back—21 Wide (Standard with reinforced hinges)

Same as above, 21" wide and over.

EZ CONF-EXT2 Easy Conforming Extended Back

This back allows contouring at the posterior and lateral planes of the trunk, and posterior support of the hips. This back has a pre-contoured shape and is constructed of 5 lightweight plastic panels that are connected to each other with adjustable locking hinges. The lateral portions can be independently positioned from a flat position to a 90-degree angle. This back can be ordered standard based on frame width, or custom ordered with patient measurements. Foam in place is an additional option.



EZ CONF-EXT2-21W Easy Conforming Extended Back - 21" wide (Standard with reinforced hinges)



GLIDE2 Back with 2 Glide Locks, 2 J's & L's and a Seat to Back Hinges

Standard solid back with (4) each #405A1 1" drop hooks, #406A1 are available at no extra charge, upon request.

Locking DH2—Solid Back with 2 Locking Drop Hooks

Standard solid back with (2) each #553 locking drop hooks. The locking drop hooks fit 1" diameter tubing only. This system provides secure back retention while allowing for quick removal from the chair.

EASY CLAMP 2 Back with 2 Easy Clamps

Standard solid back with (2) each #567 EE Easy Clamp Brackets, (2) each #403A Split Collars and (2) seat to back hinges. This hardware is designed to mount to 1" round tubing.

102-1000 Solid Back Insert with Loops

Standard solid back insert designed to be used on a sling back. This back comes with loops to attach to the back posts. Backs are cut to your specifications.

102-1000A Solid Back Insert with T-nuts

Standard solid back with one set of t-nuts. When ordering this back, you will receive all Freedom Designs, Inc. t-nuts specified. You may also order t-nuts for one manufacturer's component. Additional t-nuts for various components (not Freedom Designs, Inc.) or manufacturers will result in additional charges. Backs are cut to your specifications.

102-2000 Solid Back with 1" Drop Hooks

Standard solid back with (4) each #450A1 1" drop hooks and (4) each #436 30 degree clamps. Designed to allow easy folding of the chair while the back stays attached to the frame (when cut between the rails). Backs are cut to fit between the back posts, unless otherwise specified. Stainless steel drop hooks are available at no charge upon request

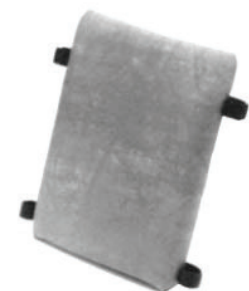



102-3000 Solid Back with 1". 2" or 3" Drop Hooks

Standard solid back with your choice of either (4) each #405A1 1" drop hooks, #406A1 2" drop hooks or #407A1 3" drop hooks and (4) each #403 split collars. This hardware is designed to fit 1", 7/8" or 3/4" round tubing. Hardware allows you to order the back with a specific amount of fixed drop, depending on your client's needs. Backs must be cut to fit between the back posts. Stainless steel drop hooks are available at no extra charge, upon request.

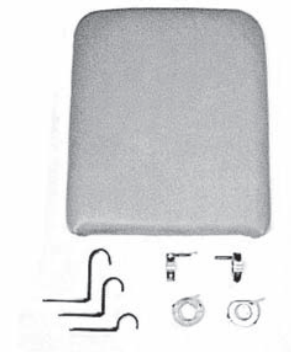

102-4000 Solid Back with J & L Brackets & Split Collars

Standard solid back with (4) each #413A L-brackets, (4) each #414A J-hooks and (4) each #403 split collar clamps. This hardware will allow up to 3" of drop or 2" of anterior adjustment. This design also allows for seat to back angle adjustment. Back will be permanently mounted and can not be removed without the use of tools. Backs are cut to fit between the back posts, unless otherwise specified. Stainless steel J & L 's are available at no extra charge, upon request. This hardware is designed to fit 1", 7/8" or 3/4" round tubing.



102-5000 Solid Back with L-Brackets

Standard solid back with (2) pair of #413A L-brackets. This combination of hardware is designed to mount on many of the chair frames that have non-round rails. Angle adjustable double L-brackets bolt directly to the frame rail in the manufacturer's pre-drilled tubing or tracked rails. Double L-brackets are sent, although you may find single L-brackets will be sufficient, depending on frame tube styles. Backs are cut to fit between the rails unless otherwise specified. Back is not quick release. Stainless steel L-brackets are available at no extra charge, upon request.



102-6000 Solid Back with Snaplock Hardware

Standard solid back with (4) each #490 Snaplock frame clamps. This light weight snap-in hardware is perfect, when a full width back is needed to mount directly on the back posts and does not require angle or depth adjustment. The hardware is designed to fit 1", 7/8" or 3/4" round tubing. This back must be cut full width. Curved wood can not be used with this hardware. I-modifications may be used and the foam can be curved, instead of wood.





102-7000 Solid Back with J & L Brackets and Quick Release Brackets

Standard solid back with (4) each #492 Crescent L-brackets, (4) each #414 J-hooks and (4) each #457 quick release frame clamps. Crescent L-brackets ensure mounting to backpost, regardless of back post angle. The light-weight lever release clamp is designed to fit 1", 7/8" or 3/4" round tubing. The adjustable J & L brackets allow change in seat to back angle and with the matching seat hardware (101-7000) can allow you to tilt the Backposts within the chair frame. Backs are cut to fit between the back posts, unless otherwise specified. Stainless steel J & L brackets are available at no additional charge, upon request.

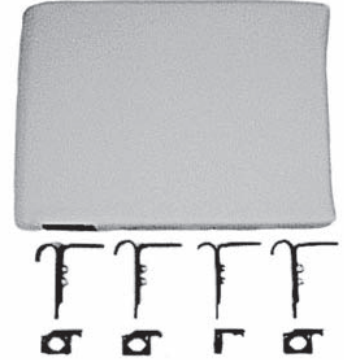

102-7500 Solid Back with ECONO-EZE Hardware

Standard solid seat with (4) each #462 frame clamps and (4) each #437A back mount forks. This hardware offers all the familiarity of our "Knob Release" hardware, with the ease of an independently mounted back. Four knob release points secure the back to the frame. Clamps are designed to fit all 3 standard sizes of round tubing and clamps are available to fit most non-round tubing currently on the market. Econo-Eze hardware offers seat to back angle and depth adjustable hardware to fit your client's needs. Backs are cut to fit between the back posts, unless otherwise specified.



102-7500-LT Solid Back with ECONO-EZE Hardware

No Longer Available

Standard solid back with 4 each #462 frame clamps and 4 each ECONO-EZE LITE back mount forks.

102-9000 Solid Back with Twister Hardware

Standard back with (4) each #494 Twister frame clamps and (4) each #413A L-brackets. This hardware is designed to mount to 1", 7/8" or 3/4" round tubing. Along with clamps that totally remove from the frame, you get L-brackets that allow for anterior / posterior and angle adjustability. Backs are cut to fit between the back posts, unless otherwise specified.





102-10000 Tension Adjustable Back Upholstery

This back allows you to contour for posterior support and personalized comfort by simply adjusting the straps. These straps are covered by a standard flap with "Freedom" monogrammed standard on the flap. We will customize the back to fit any manufacturers wheelchair. Specify width of chair, model of chair, tension adjustable back height and height of sleeves. Standard upholstery is sailcloth. Cannot be used on any Freedom Designs, Inc. frame that needs to be folded.



102-11000 Solid Back with 2 Pair of Spring Loaded Econo Eze Hardware

This an easily removed solid back that has knob style hardware and connecting forks with tension springs. The springs allow the back to be dynamic in a posterior direction, and return to an original position after client impact force subsides. The back can be pre adjusted for angle and depth.



102-12000 Easy Conforming Back—Standard

This back allows contouring at the posterior and lateral planes of the trunk and hips. This back has a pre-contoured shape and is constructed of 5 lightweight plastic panels that are connected to each other with adjustable locking hinges. The lateral portions can be independently positioned from a flat position to a 90-degree angle. This back can be ordered standard based on frame width, or custom ordered with patient measurements. Foam in place is an additional option.



102-12000-21W Easy Conforming Back—Standard, 21" Wide (Standard with reinforced hinges)

Same as 102-12000, 21" wide and over



102-13000 Easy Conforming Back—Extended

This back allows contouring at the posterior and lateral planes of the trunk, and posterior support of the hips. This back has a pre-contoured shape and is constructed of 5 lightweight plastic panels that are connected to each other with adjustable locking hinges. The lateral portions can be independently positioned from a flat position to a 90-degree angle. This back can be order standard based on frame width, or custom ordered with patient measurements. Foam in place is an additional option.



**102-13000-21W Easy Conforming Back—Extended,
21" - 26" Wide**
(Standard with reinforced hinges)

Same as above over 20" in width.

102-14000 Solid Back with 4 Glide Lock Clamps and 4 J's & L's

*Hardware: (4) crescent L/J brackets, and (4) universal glide lock securement clamps.
Foam: 1" 3lb foam
Fabric: Any choice
T-nuts: Universal pattern*

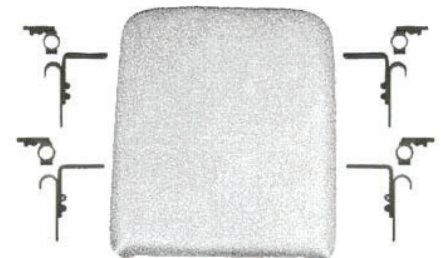

102-15000 Solid Back with 2 Pair of Econo Eze Hardware
(available on 14" W and under)

This back is cut 3" less than frame width, unless specified.

*Hardware: (4) #462 (knob slotted frame clamps), (4) #437A (back mount forks) universal tubing size
Foam: 1" 3lb foam
Fabric: Any choice
T-nuts: Universal pattern
used on any Freedom Designs, Inc. frame that needs to be folded.*



102-16000 Solid Back with 2 Glide Locks, 2 Split Collars and 4 J's & L's

This set up allows the lower J/Ls to be slid between the split collar pin and back cane and the upper J/Ls to be secured with the glide lock clamps creating a 2 point release stand alone back.

*Hardware: (4) crescent L/J brackets, and (4) universal glide lock securement clamps.
Foam: 1" 3# base
Fabric: Any choice
T-Nuts: Complete with multiple T-nuts.*

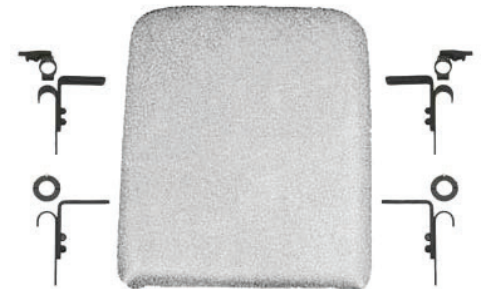



102-17000 Easy Conforming Back—Standard with 2 Glide Locks and 2 Split Collars

This back allows contouring at the posterior and lateral planes of the trunk and hips. This back has a pre-contoured shape and is constructed of 5 lightweight plastic panels that are connected to each other with adjustable locking hinges. The lateral portions can be independently positioned from a flat position to a 90-degree angle. This back can be order standard based on frame width, or custom ordered with patient measurements.



- Hardware: (4) crescent L/J brackets, and (2) universal glide lock & (2) split collars
- Foam: 1/2" 3# foam and a 1/2" medium sunmate top layer
- Fabric: Only offered with dynamic
- T-nuts: Multiple T-Nuts

102-17000-21W Easy Conforming Back—21"W Std with 2 Glide Locks and 2 Split Collars
(Standard with reinforced hinges)

Same as above, 20" and 21" in width.

102-17000-22/26W Easy Conforming Back—Heavy Duty – Standard for 22-26" Wide
(Standard with reinforced hinges)

Same as above, 22" - 26" in width.

102-18000 Easy Conforming Extended Back— with 2 Glide Locks and 2 Split Collars

This back allows contouring at the posterior and lateral planes of the trunk, and posterior support of the hips. This back has a pre-contoured shape and is constructed of 5 lightweight plastic panels that are connected to each other with adjustable locking hinges. The lateral portions can be independently positioned from a flat position to a 90-degree angle. This back can be order standard based on frame width, or custom ordered with patient measurements. Foam in place is an additional option.

This set up allows the lower J/Ls to be slid between the split collar pin and back cane and the upper J/Ls to be secured with the glide lock clamps creating a 2 point release stand alone back.



- Hardware: (4) crescent L/J brackets, and (2) universal glide lock securement clamps.
- Hardware: (2) #403 milled split collar clamps with pin.
- Foam: 1/2" 3lb base and a 1/2" medium sunmate top layer
- Fabric: Only offered with dynamic
- T-Nuts: Complete with multiple T-nuts.



**102-18000-21W Easy Conforming Back—Extended 21” W with
2 Glide Locks and 2 Split Collars**
(Standard with reinforced hinges)

Same as above, over 20” in width.

**102-18000-22/26W Easy Conforming Extended Back—
Heavy Duty for 22-26” Wide.**
(Standard with reinforced hinges)

Same as above, 22” - 26” in width.

**102-19000 Solid Back with 4 Locking Drop Hooks and 2 Split
Collars**

This back is depth adjustable and removable.

Hardware: (4) #553 Locking Drop Hooks, and (2) #404 Split Collars for 1” tubing
Foam: 1” 3 lb foam
Fabric: Any choice
T-nuts: Universal pattern



102-EASY CLAMP Solid Back with 4 Easy Clamps

*Standard solid back with (4) each #567 EE Easy Clamp Brackets and (2) each
#403A Split Collar clamps. This hardware is designed to mount to 1” round tubing.*





Mod-2A Phenolic Base

Phenolic is used instead of the plywood base. It is a dense space-age plastic 3/8" thick. Phenolic should be used when client has extreme extensor tone or where client weight is a concern.

Mod-2B Cut Outs, Foam-Wood-Upholstery

This modification will allow you to remove wood, foam or fabric from a specific area of the back. Charge each time a layer is removed. The removed area is "finished", this is not an interchangeable insert.

Mod-2E Wedge Cut Foam

This modification is designed to aid in control of rotation (wedge is lateral) or to provide additional weight bearing surface with foam (wedge is vertical or horizontal). Please specify direction of wedge and foam thickness.

Mod -2F Tabs and Snaps

For use when you need to attach a solid back insert to the frame of the wheelchair and you are not using hardware. Designed to mount over sling upholstery.

Mod-2H I Modification

Solid backs are cut into the shape of a capital I so that trunk supports and harnesses can be mounted close to the chest. The I allows for vertical adjustment. This modification can be used with any mounting hardware. Please provide all dimensions for the I modification. There are no standard sizes.



Mod-2I Curved Wood Modification

This modification gives you curved wood base on which foam and upholstery are applied. This modification can be used on all hardware, excluding Snaplock and micro. For Snaplock applications, the foam can be curved. Backs may not exceed 22" in width and 32" in height.



Mod-2IA Curved Foam Modification



Mod-2J T Modification

Solid backs are cut into the shape of a capital T to allow maximum adjustment of trunk supports and harnesses. Backs can be mounted with any Freedom Designs, Inc. seat & back combination, where a hinge is used. This modification will also work with fixed or adjustable drop hooks, providing a spreader bar is used. There are no standard sizes; please provide all dimensions.



Mod-2K Grid Back Foam

This modification changes the standard thickness of 3# foam to 2". The foam is then cut into blocks 2" wide x 2" high and attached to the back base with hook and loop. The hook & loop allows for removal, carving or replacement of the standard foam with custom foam as needed. The cover comes in two pieces and the face cover is completely removable for total access to the foam. The Removable face cover also allows for easy cleaning. (See Mod-2U for Cover Only up-charge.)

- Mod-2K1 9 Additional Foam Blocks in 3#, 4# or 5# Foam
- Mod-2K2 9 Additional Foam Blocks in Sunmate Foam or T-Foam
- Mod-2K3 9 Additional Foam blocks in Pudge Foam

*Additional foam blocks are 2" thick.
Charges may apply for additional thickness.
(See custom foam pricing and apply charges from trunk / hip).*



Mod-2L Bi-Angular Back

This back features two sections hinged together for angle adjustment. The bi-angular back may be instrumental in control of posterior pelvic tilt and head control. If the client has an anterior tilt, the bi-angular back can be used to support the thoracic spine and posterior pelvis. Available in any width or height and can be used with any mounting hardware. Must specify where split is to be.

Mod-2LA Bi-Angular Back Covered as One Piece

Mod-2M Two-Tone Upholstery

This modification is provided free of charge when multiple fabrics or colors are used on the seating surface. Two-tone fabric is quilted to reduce the opportunity for skin breakdown due to seams and hard surfaces. There is no up-charge for multiple colors / fabrics on separate surfaces.





Mod-2N Monogram Client's Name

This modification is provided free of charge when you order a system (both a seat and back with hardware on the same order). The free monogram can be up to 18 letters and we can match most frame colors on the market today. The available letter styles are pictured here. (See Mod-2T for monogram charges when a system is not ordered).

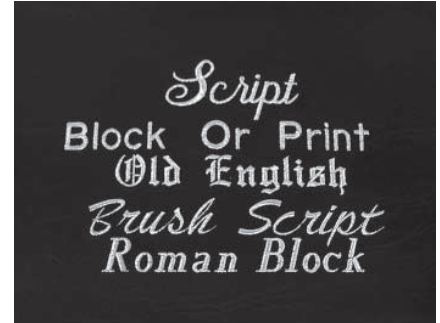

Mod-2O Grommets

Grommets are slots cut through all layers of the back and then the edges are finished. These holes allow straps to go through the back, to ensure proper positioning when the back is to the top of the head. Please provide placement of grommets on back.



Mod-2P Hook & Loop Strips

Hook or loop strips can be added to the back to attach a solid back to a sling, back pan or to attach a cushion to a Freedom Designs, Inc. back base. Please specify chair make and model or cushion manufacturer.

Mod-2Q T-nuts

T-nuts can be added to any solid back being made. Please specify mounting hardware (102-1000), component manufacturer's model number or provide a diagram of t-nut placement. Charges are one-time for all Freedom Designs, Inc. t-nuts needed or for all t-nuts for each individual manufacturer's component.

Mod-2R Standard Back Cover with Zipper

This cover is designed to fit a Freedom Designs, Inc. standard back and to be closed with staples. You must provide dimensions or original order information. Can be made to fit other custom backs when a diagram is provided.



Mod-2R2 Standard Contour Back Cover with Zipper

This cover is designed to fit a Freedom Designs, Inc. contoured back. You must provide original order information.

Mod-2R2C Custom Contour Back Cover with Zipper

Mod-2S Free Form Back

The Free Form modification is foam-in-place seating. This molding system is designed to interface with all Freedom Designs, Inc. positioning components. This system provides the capability to mold the most difficult client with fixed deformities and still provide aggressive positioning with thoracic supports, shoulder retractors, chest vests and headrests. Each kit contains Sunmate chemicals, gloves, safety goggles, bag and a bucket for mixing. The solid back will come with 1" foam of your choice (except Pudgee) to prevent bottoming out by client. The cover has 1/4" Sunmate foam sewn inside of the contact surface for added comfort. For best results, the cover should be made of stretch fabric.



Mod-2S1 Free Form Chemicals Only

This modification will give you the liquid Sunmate chemicals, pour bag, mixing bucket and safety gear. This is what you need if you already have the back and cover and need to repour or if you need extra chemicals.

Mod-2S2 Lateral Blocker Kit

This is a one-time purchase by the dealer. Lateral blockers help keep the foam from expanding on the sides of the back and direct the foam towards the client.

Mod-2S3A Free Form Cover Upgrade (No Chemicals)

Use this modification when you are ordering a back and only need the cover to complete the Free Form pour. The cover will have zippers on the top of the back. The cover has 1/4" Sunmate foam sewn inside of the contact surface for added comfort. For best results, the cover should be made of stretch fabric.



Mod –2S3AC Custom Free Form Cover Only

Use this modification when a cover is all you are ordering. The cover has 1/4" summate foam sewn inside of the contact surface for added comfort. The cover will have bi-lateral zippers at the top of the back. For best results, the cover should be made of a stretch fabric.

Please give exact dimensions for cover. Width x Height x Thickness

Mod –2S3B Custom Contour Free Form Cover Only

This is a free form cover for an existing deep molded / contoured back. The cover has 1/4" summate foam sewn inside of the contact surface for added comfort. Bi-lateral zippers are at the top of the back. A detailed drawing is required for this cover to be manufactured or an existing mold must be sent to our factory for price quote and / or construction. For best results, the cover should be made of a stretch fabric.

Mod –2S4 Internal Lateral Supports

These lateral supports are designed to mount under the cover of a Free Form back. Mounting with narrow L-brackets, the perforated wood base allows the foam to surround the wood base. This gives a rigid lateral support that will allow firm positioning, regardless of tone. The top and side edges of the wood base have padding for protection and comfort. Please specify the size you need. Length x Height. For accurate cover contour (when needed) please provide top of support placement.



Mod-2T Monograms (no system ordered)

Use this modification when you would like a monogram and have not met the criteria for a free monogram. See Mod-2N for specifics on how to qualify for a free monogram.

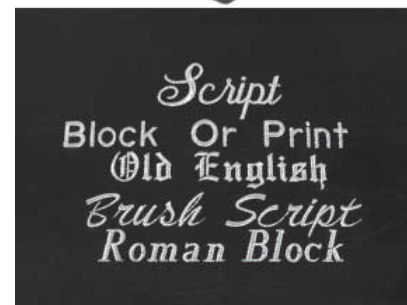



Mod-2U Removable Grid Style Cover

Use this modification when you are ordering a back and wish to incorporate a removable cover on the back or an extra face cover when a grid is ordered. The cover comes in two pieces and the face cover is completely removable for total access to the foam. The removable face cover also allows for easy cleaning



Mod-2UA Removable Grid Style Cover (No back ordered)

Use this modification when you are only ordering the cover and no back is ordered. Please specify face cover only, rear cover only or complete set. Charges double when ordering a set. Please provide all dimensions or original order information. Width x Height x Thickness



Mod-2UAC Custom Removable Grid Style Cover (No back ordered)

This is a modification for a back being ordered that a custom grid cover is required. The custom element is limited to general depth and height of laterals, starting/ending point of generic lateral taper. For more exact shapes in several planes Mod-2S3B should be used.



Mod-2V Round Off Bottom or Top of Back

Use this modification when you need a special radius on the top of the back or you need the bottom of the back to fit into another manufacturer's seat base.

Mod-2W Foam Full Width—Wood Between Rails

This modification is designed to provide additional seat depth when the chair is at its maximum. The wood is cut to fit between rails and the foam is cut full width. At least 1" of foam must be over the rails. This may also be used on solid seats to decrease seat to floor height. Some restriction in mounting lateral support pads may be encountered.



Mod-2X Scapular Cut Outs

The scapular cut outs are designed to provide an unrestricted range of motion for those who propel their chair. Standard sizes are available based on width of back or you may specify width x height.



Mod-2Y Contour Back Foam

This modification can give you lateral support or simply a specified curve to your back. When ordered without specific dimensions, you will receive mild lateral supports based on width and height of the back. Please provide a diagram when requesting specific size and placement.



Mod-2Z Zipper Closure

Use this modification when you wish to have a zipper closure on the bottom of the back. For "I" & "T" modifications, the zipper must go beyond the widest portion of the back.

Mod-2BB Monogram Design

Freedom Designs, Inc. offers a variety of designs that can be embroidered on your back. Please contact the Customer Service Department to discuss the available designs. Pricing is based on the number of stitches required to make the design. Ask Customer Service about our 10 no charge designs.

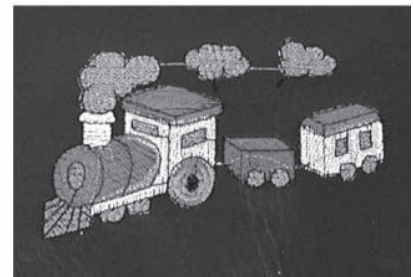

Mod-2DD Built-in Adjustable Lumbar

*The hardware is integrated in the construction of the solid back. Tracks give 4" vertical adjustment, while up to 4" of anterior adjustment is controlled by the double-knobbed all thread bars. Maximum anterior adjustment is achieved when a soft stretch fabric is used. Please specify where to start track in relation to the bottom of the back.
Solid back mount only.*

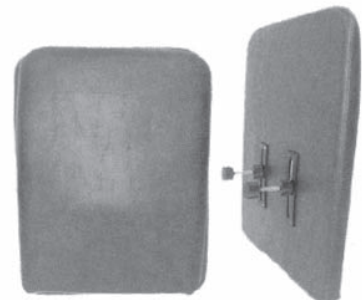



Mod-2EE Checker Board Cut Foam

This modification takes the standard 1 1/2" 4# foam and cuts it partially into 1" wide x 1" deep blocks. This breaks up resistance of the foam for patient comfort. Blocks are not removable. For best results when checker boarding, a stretch fabric is suggested. Custom foams are available in any thickness, please specify.



Mod-2FF Modular Back Contour Cushion

This is a modification to a back, which creates an adjustable contoured cushion. There is fire retardant etha-foam used to create the lumbar and thoracic supports that are velcroed to the base wood with a foam overlay, and zippered cover for access. These supports can be adjusted, removed or contoured, with an electric knife, to create the desired fitting. The lumbar and thoracic supports are layered to change the pitch and precut in 1" sections. This modification can be changed over time for an ever changing client or be used for multiple evaluations.



Mod -2GG Ergo Adjustable Back Modification

This is a modification to a back that is curved wood with a adjustable locking bi-angular function and adjustable locking vertical hip wings all under one cover. The hinges have easy allen head adjustment bolts allowing fine tune adjustment with the client in the chair. Standard set up is bi-angular cut at 1/3 rd the overall height of the back, and hip wings 3" wide. Stretchable face cover fabric is recommended.



Mod-2HH Ergo Adjustable Back with No Biangular Cutout

Mod -2II Ergo Wings with Hinges Only



Mod -2JJ Track Mount Hardware—Single Tracks

These are single rowed tracks that are attached with wood screws to a back. They allow mounting hardware and lateral trunk brackets to be mounted in a "sliding" track for easy adjustment.





Mod -2KK 1/4" Thick Applewood

*The base wood of the back is 1/4" instead of 1/2".
For 14" and under systems only.*

Mod -2LL Easy Conforming Back Cover (102-12000)

Mod -2MM Easy Conforming Back Cover (102-13000)

Mod -2NN Easy Conforming Back Flap

Mod -2OO Easy Conforming Back Wing—Inner

Mod -2PP Easy Conforming Back Wing—Outer

Mod -2QQ Easy Conforming Back Split Wings

*The inner and outer wings are horizontally split to allow for independent adjustment.
The cover is not split.*

Packages

Kidlet

This package consists of EE1, Mod-1Y built in contour, EE2, Mod-2H I-Mod, Mod-2I/Mod-2IA curved wood or foam, tracks for trunk supports + hip guides and medium T-Foam in seat and back (EE1 & EE2 include "Micro" hardware) Available for 14" wide and under wheelchairs.

E1012PK2

No Longer Available

Planar seat, planar back & seat to back hinge

E1013PK4

No Longer Available

Contour seat, curved foam back & seat to back hinge

E1013PK5

No Longer Available

Anti-thrust seat, curved foam back & seat to back hinge

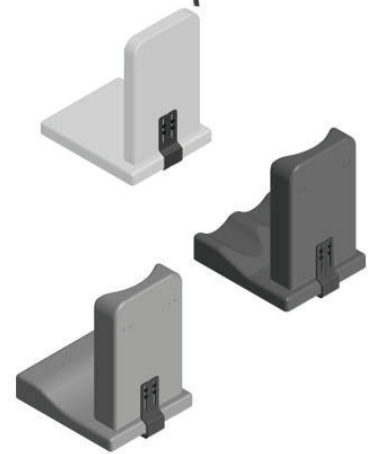



Medial Thigh Supports

Freedom Designs, Inc. Medial Thigh Supports are constructed of a wood block base, with 4# foam surrounding the base (foam thickness increases with pad size) and your choice of fabric. A genital relief is added for extra client comfort.

Medial Thigh Supports are available in the following standard sizes:

<i>SMALL</i>	<i>3L x 3H x 3-2 taper</i>
<i>MEDIUM</i>	<i>4L x 3H x 3-2 taper</i>
<i>LARGE</i>	<i>5L x 4H x 4-2 taper</i>
<i>X-LARGE</i>	<i>6L x 5H x 5-3 taper</i>

Custom sizes available at no additional charge.

Pelvic Belts

Freedom Designs, Inc. Pelvic Belts are constructed of high quality nylon webbing in 1", 1 1/2" or 2" webbing. All pelvic belts come with iliac crest relief pads for added client comfort. Our hip belts come with a choice of frame mounting options. You may choose between standard grommet attachment or mounting plates with double D-ring slides.

Standard sizes are available based on chair width as follows:

<i>SMALL</i>	<i>10" W—12"W CHAIR</i>	<i>1" WEBBING</i>
<i>MEDIUM</i>	<i>13" W—15"W CHAIR</i>	<i>1 1/2" WEBBING</i>
<i>LARGE</i>	<i>16" W & OVER</i>	<i>2" WEBBING</i>



EE3A Medial Thigh Support—Adjustable/Removable

This medial thigh support has star knob release hardware for easy slide or removal. Thin profile hardware permits mounting when cross tube or strut hinders other hardware.

Extension brackets are available for high profile cushions.



EE3B-2 Medial Thigh Support with Flip Down Bracket

The design of this streamlined flip down hardware, allows the pad to flip under the seat to facilitate transfer. The large push button release is easy to access. The pad returns to the same position each time. Extension brackets are available for high profile cushions.

Can be mounted to a seat pan.



EE3C Hip Belt with Squeeze Side Release Plastic Buckle

This hip belt is lightweight and durable. There is an additional webbing size available on this hip belt only. 3/4" webbing with a 3/4" buckle can be made for your smallest positioning needs.



EE3D Hip Belt with Push Button Buckle

This hip belt features the three standard webbing sizes and buckles to match. The push button style buckle features push button release. The EE3D will fill positioning needs. Designed to be mounted to the frame, both grommets or mounting plates with slides are available. Please specify your preference. Hip belt pads come standard, slim-line or contour pads are available as a no charge option.





EE3E Medial Thigh Support with Adjustable Flip Bracket

This abductor features depth adjustable convenience, combined with flip down hardware. This hardware can be mounted with a knob for continual changes or bolt mounted to ensure no changes. Please specify your requirements. Easy access lever release facilitates transfer. Short bracket (non-depth adjustable) available for chairs with cross tube or strut restrictions. Extension brackets available for high profile cushions.



EE3F 2-Point Control Hip Belt

No Longer Available

This belt features a leader off the buckle with double ends attaching to the chair. With dual ends, you have the ability to adjust the angle of the tensions on the belt. Available in both squeeze release and push button style buckles. This belt attaches to the seat rail and back post. Also available with plastic buckle in 3/4" webbing. Hip belt pads come with standard, slim-line or contour pads as a no charge option.



EE3G Sub A.S.I.S. Bars with Swing Away Hardware

Sub A.S.I.S. bars aid in control of pelvic rotation and thrust. The hardware lifts to swing away for easy transfer. Pad and bar size determined by hip width. Depth and angle adjustable hardware provides added comfort. Contraindicated when hip integrity is in question. Notches in solid back may be required for proper fit. Right part shown

No Longer Available

EE3H Knee Blockers

These knee blockers can provide adduction and abduction control when used with a pelvic belt. Lift and swing away hardware aids in transfer. Hanger mounted hardware size is based on chair width and manufacturer. Standard pad sizes available, based on chair width or you may specify needs. May be contra indicated if hip or knee integrity is in question. Left part shown

No Longer Available



EE3I Hip Belt with Airline Style Buckle

This belt features an airline buckle that is easy to release. The large pull lever mechanism makes it possible for user release, with only large motor skills. Available only in 1 1/2" and 2" webbing. Hip belts come with standard, slim-line or contour pads as a no charge option.



EE3J 4-Point Hip Belt

This hip belt features bilateral double webbing straps attaching to the buckle. The close proximity of double straps to the buckle aid in pelvic control. Available in squeeze release or push button buckles. Designed to mount to the seat rail and back post, you can position the most involved client. Available in standard webbing sizes with push button style and additional 3/4" webbing in squeeze plastic buckle. Hip belts come with standard, slim-line or contour pads as a no charge option.



EE3K Internal Adjustable Abductor

This built-in hardware gives you an adjustable abductor build up in the seating surface. Knob hardware allows up to 4" of vertical adjustment (with stretch fabric). 4" depth may be placed in any position; please specify. Shown with lateral thigh supports



EE3L Hip Belt Guides

These guides will prevent the hip belt from falling down in the wheels. Both seat rail (Short) and axle mount (Long) lengths are available. These guides can be ordered for each webbing size; if no size is specified, short guides for 2" webbing will be sent (this will fit all webbing sizes).

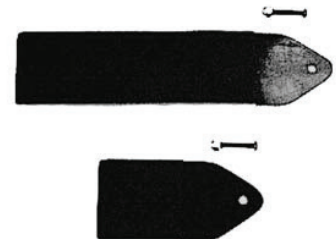



EE3M Anti Thrust Pelvic Harness

This is a harness that rests on top of the seat under the buttocks. The anterior straps come between the legs and outward over the thighs and buckle near the proximal hip/thigh. The straps are adjustable for different degrees of tension.



EE3N – (Series) Medial Thigh Support/ Abductor with vertical release optional top plates for adjustments. Hardware and pads included in base price. Custom size pads.



EE3N-CTP: Child Top Plate



EE3N-STP: Short Top Plate



EE3N-LTP: Long Top Plate



EE3N-2HTP: 2 Hole Top Plate



EE30- (Series) Medial Thigh Support/ Abductor with horizontal release optional top plates for adjustments. Hardware and pads included in base price. Custom size pads.

EE30-CTP Horizontal Release with Child Top Plate



EE30-STP Horizontal Release with Short Top Plate



EE30-LTP Horizontal Release with Long Top Plate



EE30-2HTP Horizontal Release with 2 Hole Top Plate





EE3P Hide Away Abductor—(Flip Down)

This Flip Down Abductor has an easy release lever underneath the seat which facilitates transfer.

The flip top plate comes in standard height or with an extension for high profile cushions.



EE3Q Horizontal Release with Oval Pad (small, medium or large)



EE3R Vertical Release with Oval Pad (small, medium or large)





Mod-3D Sealed Incontinent Liner

This shear plastic film covers the medial thigh support pad to prevent moisture from touching the wood and foam, giving the pad a longer use life.

Mod-3E Medial Thigh Support Pad Only

Replacement pad to fit Freedom Designs, Inc. hardware. Please specify mounting hardware to assure correct t-nut placement. Standard sizes available or you may specify requirements at no additional charge.



Mod-3F Extension Bracket

Use this modification when ordering a medial thigh support that requires elevation for seat cushion height. Please specify type of hardware in use, if not ordering hardware with extension.



Mod-3G Width and Angle Hardware

This modification gives you two separate pads hinged together. The track mounted hinge allows for width and depth adjustment. There are no standard sizes for this modification. Please provide Length x Height dimensions. This modification is not available on EE3A hardware.



Mod-3H Hip Belt Pads Only

Replacement pads for hip belts are available to fit all webbing sizes. Please specify pad length, webbing width and upholstery number.





Mod-3I Medial Thigh Support Pad Cover Only

*Replacement covers are available as a recover or sent to you non-mounted. Covers sent without pad require staple closure. Please specify all pad dimensions when you order cover only.
Length x Height x Taper*

Mod-3J Extension Bracket for EE3P Hide Away Abductor

This bracket gives overall height cushion clearance of 3.5 inches



Mod-3K Oval Abductor Pads & Vertical Slide Bar for EE3N-EE3O Series

This contains 2 oval pads with an ABS base 1/2" medium summate foam that are bolted to a vertical bar with a draw string cover. Pad size (x") high x (x") deep.



Mod-3L Reinforcement of Anti-Thrust Pelvic Harness (EE3M)

There is addition webbing sewn into the EE3M dynamic harness to limit the amount of overall stretch.

Mod-3M Fabric Boot for Abductor Hardware.

This is a padded fabric sleeve that goes over the vertical front facing hardware of any F.D.I. abductor bracket to protect inner knee, skin and tissue.





The Standard Lateral Pad

The standard pelvic/thigh support pads are constructed of 1/2" marine grade plywood with 1" of 4# foam and your choice of fabric. Pads ordered with hardware will come with t-nuts (excluding 104-3000). Thin profile pads are available upon request at no additional charge. These pads are made with a 1/4" ABS base and 1/4" neoprene foam. There are no standard sizes for lateral pads. You must specify all dimensions.

Length x Height x Thickness

For pads of 14" in length or more, we recommend an additional set of mounting brackets.



104-1000 Lateral Pelvic/Thigh Inserts with Loops
(No Hardware)

These pads are designed to attach to the armrests of the chair. Tabs and snaps at both ends of the pads make mounting quick and easy. Please specify all dimensions. Tab placement may be specified if needed.

- 104-1000-STD Standard 4# foam**
- 104-1000-SUN Medium Sunmate**
- 104-1000-T-Foam Medium T-Foam**
- 104-1000-THIN Thin foam / ABS**



EE4A Lateral Pelvic/Thigh Supports—Solid Seat Mount

The hardware attaches to the bottom of the seat. Slotted L-brackets allow for width adjustment. All t-nut spacing for pad and seat is on 1" centers. Please specify all pad dimensions.

- EE4A-STD Standard 4# foam**
- EE4A-SUN Medium Sunmate**
- EE4A-T-FOAM Medium T-Foam**
- EE4A-THIN Thin foam / ABS**

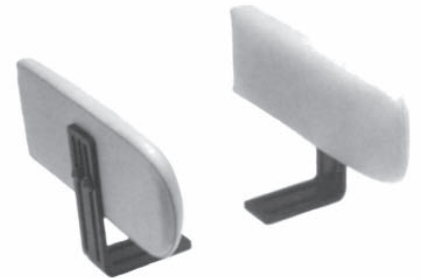

EE4B Lateral Pelvic/Thigh Supports—Solid Seat Mount Offset

The hardware for these pads mount to the bottom of a solid seat. This hardware comes in 1" or 2" offset toward the midline and 1" reverse offset. Slotted L-brackets allow width adjustment. Please specify all pad dimensions and desired offset. If no offset is specified, 1" offset will be sent. Extensions are available for high profile cushions.

- EE4B-STD Standard 4# foam**
- EE4B-SUN Medium Sunmate**
- EE4B-T-FOAM Medium T-Foam**
- EE4B-THIN Thin foam / ABS**
- EE4B-1-15-STD Standard 4# foam, offset 15° bend**
- EE4B-1-15-SUN Med Sunmate, offset 15° bend**
- EE4B-1-15-T-FOAM Med T-Foam, offset 15° bend**
- EE4B-1-15-THIN Thin foam , offset 15° bend / ABS**

No Longer Available

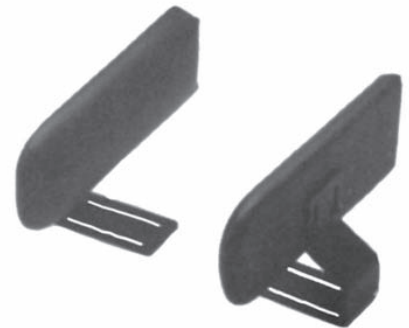



104-3000 Lateral Pelvic/Thigh Supports—Armrest Mount

Designed to mount to the armrest with 1" drop hooks and 30° clamps. Pads are not t-nutted, (bee stingers are included) as hardware will not always mount symmetrically, (T-nuts may inhibit your ability to mount hardware). Please specify all pad dimensions.

- 104-3000-STD Standard 4# foam**
- 104-3000-SUN Medium Sunmate**
- 104-3000-T-FOAM Medium T-Foam**



EE4C Lateral Pelvic/Thigh Support—Quick Release Brackets

Our pull knob hardware is designed to quick release below the surface of a standard Freedom Designs, Inc. seat to allow a comfortable lateral transfer. Hardware is available in L, 1" and reverse offset. Please specify all pad dimensions. Extensions are available for high profile cushions.

- EE4C-STD Standard 4# foam**
- EE4C-SUN Medium Sunmate**
- EE4C-T-FOAM Medium T-Foam**
- EE4C-THIN Thin foam / ABS**

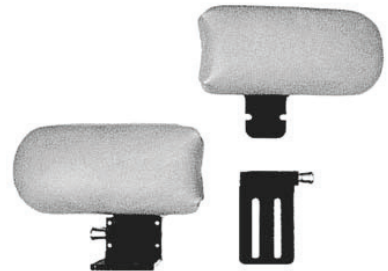

EE4D Hanger Mounted Knee Adductor

This adductor has a multi-adjustable bracket and pad. Swing away functionality can be achieved when mounted to a swing away hanger. Fits 1" diameter hanger tubes.

- EE4D-STD Standard 4# foam**
- EE4D-SUN Medium Sunmate**
- EE4D-T-FOAM Medium T-Foam**



EE4E Lateral Pelvic/Thigh Supports—Fixed with Height Adjustable Armrests

Lateral pads are mounted on fixed hardware in L-bracket, 1" or 2" offset. Attached to the pad is a height adjustable armrest pad. Please specify L or offset hardware. Please specify lateral pad and armrest pad dimensions. Extensions are available for high profile cushions.

- EE4E-STD Standard 4# foam**
- EE4E-SUN Medium Sunmate**
- EE4E-T-FOAM Medium T-Foam**
- EE4E-THIN Thin foam / ABS**





EE4F Lateral Pelvic/Thigh Supports—Fixed with Quick Release Height Adjustable Armrests

Lateral pads are mounted on fixed hardware in L-brackets, 1" or 2" offset. Attached to the pad is a pull knob quick release armrest. This hardware allows the removal of the armrest for propelling, while maintaining pelvic control. Please specify L or offset hardware. Please specify lateral pad and armrest pad dimensions. Extensions are available for high profile cushions.

- | | |
|--------------------|-------------------------|
| EE4F-STD | Standard 4# foam |
| EE4F-SUN | Medium Sunmate |
| EE4F-T-FOAM | Medium T-Foam |
| EE4F-THIN | Thin foam / ABS |



EE4G Lateral Pelvic/Thigh Supports Quick Release with Height Adjustable Armrests

Quick release at hip guide. Lateral pads are mounted on quick release hardware in L-bracket, 1" or 2" offset. Attached to the pad is a height adjustable armrest. Please specify L or offset hardware.

- | | |
|--------------------|-------------------------|
| EE4G-STD | Standard 4# foam |
| EE4G-SUN | Medium Sunmate |
| EE4G-T-FOAM | Medium T-Foam |
| EE4G-THIN | Thin foam /ABS |



EE4H Lateral Pelvic/Thigh Supports Quick Release with Quick Release Height Adjustable Armrests

Quick release at hip guide and armrest. Lateral pads are mounted on quick release hardware in L-bracket, 1" or 2" offset. Attached to the pad is a quick release armrest.

Please specify L or offset hardware.

- | | |
|--------------------|-------------------------|
| EE4H-STD | Standard 4# foam |
| EE4H-SUN | Medium Sunmate |
| EE4H-T-FOAM | Medium T-Foam |
| EE4H-THIN | Thin foam / ABS |



EE4I Tracks for Pelvic/Thigh Support

EE4I-DUAL Dual Tracks for Pelvic/Thigh Support



Mod-4A Custom Contour Lateral Pads

Use this modification when ordering an anti-thrust or wedge seat and you need the pads to match the contour of the seat foam. You may give dimensions for the contour or we can contour the pads, based on seat foam and lateral pad placement.

- | | |
|-----------------------------|--------------------------------------|
| EE5K-TR-SUN MICRO | Med Sunmate / tracks—Micro |
| EE5K-TR-T-FOAM MICRO | Med T-Foam / tracks—Micro |
| EE5K-TR-THIN MICRO | Thin foam / tracks—Micro/ ABS |



Mod-4B Lateral Pelvic/Thigh Support Pads Only

Use this modification when you need pads only. Pads will come t-nutted for Freedom Designs, Inc. hardware. Please specify pad dimensions: Length x Height x Thickness (if other than standard).

- | | |
|----------------------|-------------------------|
| MOD-4B-STD | Standard 4# foam |
| MOD-4B-SUN | Medium Sunmate |
| MOD-4B-T-FOAM | Medium T-Foam |
| MOD-4B-THIN | Thin foam / ABS |

Mod-4C Hip/Thigh Support Upholstery Cover Only

This modification can be used to order upholstery for existing pads or when returning pads for recover to our factory. (Must have a valid Return Authorization #). When ordering covers only, please provide all dimensions or original order information. Covers sent will require staple closure.

Mod-4D Extension Brackets

Longer brackets may be needed when using a seat that is thicker than the Freedom Designs, Inc. standard seat of 2". When ordering seat and hardware at the same time, correct length brackets will be sent. When ordering for retrofit, please specify total seat thickness and type of hardware.



Mod-4E Locking Adjustable Hinged Hip Guides

This modification allows adjustment to custom fit the contour as necessary. It is made up of two separate pads, covered with stretch material and joined with an adjustable hinge bracket.



Mod-4F Locking Adj. Hinged Hip Guides—3 Pads

This modification is the same as Mod-4E but has 3 pads (2 hinged).



The Standard Trunk Support Pads

Freedom Designs, Inc. offers a variety of thoracic support pad styles based on hardware style. When ordering fixed hardware, standard pads are always sent flat. This flat pad is made of 1/2" of marine grade plywood base with 4# foam on top. Thickness of foam increases with pad size to ensure client comfort. Average thickness of these pads is 1". Hardware that swings away or is quick release comes standard with curved pads. Curved pads have a 1/4" ABS base with the same 4# foam in graduated thickness, dependent on pad size. Pads average 1" in thickness. Thin profile pads are available upon request at no additional charge. These pads have a 1/4" ABS base and 1/4" high density neoprene foam. Pads average 3/4" thickness. Thin profile pads may be ordered flat or curved. With all pads, foam is rolled over edges to ensure client comfort. All pads have multiple T-nuts for added adjustment. Dual slotted hardware is 1" on center. Pads are covered in any upholstery you specify. There is no up-charge to make custom pad sizes.

Standard sizes are available as follows:

	FLAT PADS		CURVED PADS
SMALL	4L X 3H	SMALL	6L X 3H
MEDIUM	5L X 4H	MEDIUM	7L X 4H
LARGE	6L X 5H	LARGE	8L X 5H
X-LARGE	7L X 6H	X-LARGE	9 1/2L X 6H



EE5A Lateral Thoracic Supports Fixed Hardware—L-Bracket

This hardware features a slim, light weight design. Slotted at both the pad mounting and at the back mounting locations, this hardware offers a wide adjustment range. This assembly has flat pads. Standard sizes are available and there is no up-charge for custom sizes. Solid back mount.



- | | |
|--------------------------|-------------------------------------|
| EE5A-STD | Standard 4# foam |
| EE5A-SUN | Medium Sunmate |
| EE5A-T-FOAM | Medium T-Foam |
| EE5A-THIN | Thin foam / ABS |
| EE5A-TR-STD | Standard 4# foam with tracks |
| EE5A-TR-SUN | Med Sunmate with tracks |
| EE5A-TR-T-FOAM | Med T-Foam with tracks |
| EE5A-TR-THIN | Thin foam with tracks / ABS |
|
 | |
| EE5Q-SUN-MICRO | Medium Sunmate foam—Micro |
| EE5Q-T-FOAM MICRO | Medium T-Foam—Micro |
| EE5Q-THIN MICRO | Thin Foam—Micro / ABS |

EE5B Lateral Thoracic Supports Fixed Hardware—Offset

This streamlined hardware features your choice of 1" or 2" offset toward midline or 1" reverse offset. Pads are flat when ordered with this hardware. Standard sizes are available or you may specify pad size. Solid back mount.

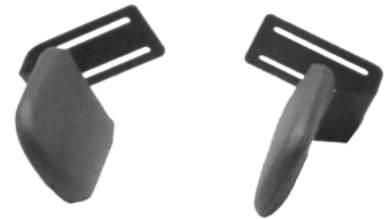

- | | |
|-----------------------|-------------------------------------|
| EE5B-STD | Standard 4# foam |
| EE5B-SUN | Medium Sunmate |
| EE5B-T-FOAM | Medium T-Foam |
| EE5B-THIN | Thin foam / ABs |
| EE5B-TR-STD | Standard 4# foam with tracks |
| EE5B-TR-SUN | Med Sunmate with tracks |
| EE5B-TR-T-FOAM | Med T-Foam with tracks |
| EE5B-TR-THIN | Thin foam with tracks / ABS |



EE5C Hinged Lateral Thoracic Supports with Anterior Trunk Support Strap

This combination of hardware, pad and strap provide both lateral and anterior support. Brackets swing away (non-locking) for transfer. Free swinging hinges, together with anterior strap, allow for some trunk movement while still providing ample support. Hardware is available in L-brackets, 1" or 2" offset. Pads come curved unless otherwise specified. Solid back mount



- | | |
|-----------------------|-------------------------------------|
| EE5C-STD | Standard 4# foam |
| EE5C-SUN | Medium Sunmate |
| EE5C-T-FOAM | Medium T-Foam |
| EE5C-THIN | Thin foam / ABS |
| EE5C-TR-STD | Standard 4# foam with tracks |
| EE5C-TR-SUN | Med Sunmate with tracks |
| EE5C-TR-T-FOAM | Med T-Foam with tracks |
| EE5C-TR-THIN | Thin foam with tracks / ABS |

EE5D Anterior Trunk Support Strap

Designed to be mounted to the thoracic support pads. This strap comes with a hook & loop and D-ring closure, padded for client comfort. Strap and pad sizing based on chest width. Available in all upholstery colors. May be dynamic or buckle closure if requested.



EE5DA Anterior Trunk Support Strap

This strap is designed to mount to a solid back. It has all the design features of the EE5D. Strap length is based on chair width. Pad size is based on client chest width. May be dynamic or buckle closure if requested.





EE5E Lateral Thoracic Support—Locking Swing Away Hardware

The hardware lifts to swing away, aiding in ease of transfer and returning to the original position when locked into place. Micro sizes have a single slotted connecting pad bracket. Pads come curved, unless otherwise specified. Hardware is available in L-bracket, 1" and 2" offsets, please specify. Dual slotted hardware allows for ample adjustment. Solid back mount.



EE5E-STD Standard 4# foam

EE5E-SUN	Medium Sunmate
EE5E-T-FOAM	Medium T-Foam
EE5E-THIN	Thin foam / ABS
EE5E-TR-STD	Standard 4# foam with tracks
EE5E-TR-SUN	Med Sunmate with tracks
EE5E-TR-T-FOAM	Med T-Foam with tracks
EE5E-TR-THIN	Thin foam with tracks / ABS
EE5E-STD-MICRO	Standard 4# foam—Micro
EE5E-SUN-MICRO	Medium Sunmate foam—Micro
EE5E-T-FOAM MICRO	Medium T-Foam—Micro
EE5E-THIN MICRO	Thin Foam—Micro / ABS
EE5E-TR-STD MICRO	Std 4# foam/ tracks—Micro
EE5E-TR-SUN MICRO	Med Sunmate / tracks—Micro
EE5E-TR-T-FOAM MICRO	Med T-Foam / tracks—Micro
EE5E-TR-THIN MICRO	Thin foam / tracks—Micro/ ABS

EE5F Lateral Thoracic Supports—Fixed Hardware

The hardware is designed to mount to the back posts. Hardware will fit 1", 7/8" or 3/4" round tubing. Adjustable hardware allows for a range of chest width settings.



EE5F-STD Standard 4# foam

EE5F-SUN	Medium Sunmate
EE5F-T-FOAM	Medium T-Foam
EE5F-THIN	Thin foam / ABS



EE5G Lateral Thoracic Supports—Quick Release Hardware

The hardware has a pull knob quick release mechanism. The receiving bracket is behind the contact surface of a standard Freedom Designs, Inc. back, allowing for an easy lateral transfer. Hardware is available in L-bracket and 1" offset, please specify. Pads come curved unless otherwise specified.

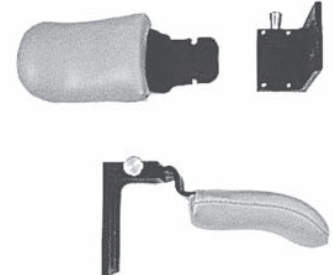

- | | |
|-----------------------|-------------------------------------|
| EE5G-STD | Standard 4# foam |
| EE5G-SUN | Medium Sunmate |
| EE5G-T-FOAM | Medium T-Foam |
| EE5G-THIN | Thin foam / ABS |
| EE5G-TR-STD | Standard 4# foam with tracks |
| EE5G-TR-SUN | Med Sunmate with tracks |
| EE5G-TR-T-FOAM | Med T-Foam with tracks |
| EE5G-TR-THIN | Thin foam with tracks |

EE5I Tracks

Tracks may be added to solid backs or seats for infinite adjustability of trunk supports or lateral thigh supports up and down the track. These tracks retrofit any solid back mount trunk supports or seat mounted lateral thigh supports. We also have dual tracks available, see parts list for item number. Sizes: 3", 5", 7", 9" & 11"



105-6000 Posterior Lumbar Support Pad

This pad is made of 5# foam. Attaching with either a webbing strap with plastic buckle or hook & loop attachment. Hook & loop attachment may be outside of the cover (standard) or under the cover (request). Please provide all dimensions: Length x Height x Thickness. Please specify mounting style: Hook & loop to attach or strap mount.



105-7000 Posterior Lumbar Support—Internal

The hardware is integrated in the construction of the solid back. Tracks give 4" vertical adjustment, while up to 4" of anterior adjustment is controlled by double knobbed all thread bars. Maximum anterior adjustment is achieved when a soft stretch fabric is used. Please specify where to start track in relation to the bottom of the back. Solid back mount only





EE5J Lateral Thoracic Supports/Fixed Hardware with Summer/Winter Lateral Adjustment

This hardware is designed with pull knob release width adjustment. The hardware allows for removal of heavy winter clothing, enabling the pads to be returned to a more proximal position while inside. Curved pads are standard unless otherwise specified. Brackets come in L, 1" or 2" offset, please specify. Solid back mount.



- | | |
|-----------------------|-------------------------------------|
| EE5J-STD | Standard 4# foam |
| EE5J-SUN | Medium Sunmate |
| EE5J-T-FOAM | Medium T-Foam |
| EE5J-THIN | Thin foam / ABS |
| EE5J-TR-STD | Standard 4# foam with tracks |
| EE5J-TR-SUN | Med Sunmate with tracks |
| EE5J-TR-T-FOAM | Med T-Foam with tracks |
| EE5J-TR-THIN | Thin foam with tracks / ABS |

EE5K Lateral Thoracic Supports—Locking S/A with Summer/Winter Lateral Adjustment

This hardware is designed with pull knob release width adjustment. Locking swing away brackets aid in ease of transfer. Hardware allows for removal of heavy winter clothes to a more proximal position while indoors. Micro sizes have a single slotted connecting pad bracket. Curved pads are standard unless otherwise specified. Brackets come in L, 1" and 2" offset, please specify. Solid back mount



- | | |
|-----------------------------|--------------------------------------|
| EE5K-STD | Standard 4# foam |
| EE5K-SUN | Medium Sunmate |
| EE5K-T-FOAM | Medium T-Foam |
| EE5K-THIN | Thin foam / ABS |
| EE5K-TR-STD | Standard 4# foam with tracks |
| EE5K-TR-SUN | Med Sunmate with tracks |
| EE5K-TR-T-FOAM | Med T-Foam with tracks |
| EE5K-TR-THIN | Thin foam with tracks / ABS |
| EE5K-STD-MICRO | Standard 4# foam—Micro |
| EE5K-SUN-MICRO | Medium Sunmate foam—Micro |
| EE5K-T-FOAM MICRO | Medium T-Foam—Micro |
| EE5K-THIN MICRO | Thin Foam—Micro / ABS |
| EE5K-TR-STD MICRO | Std 4# foam/ tracks—Micro |
| EE5K-TR-SUN MICRO | Med Sunmate / tracks—Micro |
| EE5K-TR-T-FOAM MICRO | Med T-Foam / tracks—Micro |
| EE5K-TR-THIN MICRO | Thin foam / tracks—Micro/ ABS |



EE5L Lateral Thoracic Supports—4 Pad / Fixed Brackets & Anterior Trunk Support Strap

The hardware offers a rear fixed pad with the anterior pad on a free swinging hinge. Anterior trunk support strap closes the pads. Client trunk width and depth should be taken to ensure proper fit. Please specify all pad sizes. Brackets available in L, 1" or 2" offset, please specify. Solid back mount.



EE5L-STD	Standard 4# foam
EE5L-SUN	Medium Sunmate
EE5L-T-FOAM	Medium T-Foam
EE5L-THIN	Thin foam / ABS
EE5L-TR-STD	Standard 4# foam with tracks
EE5L-TR-SUN	Med Sunmate with tracks
EE5L-TR-T-FOAM	Med T-Foam with tracks
EE5L-TR-THIN	Thin foam with tracks / ABS

EE5M Lateral Thoracic Support—4 Pad Locking Swing Away Hardware / Anterior Trunk Support Strap

The hardware offers a lift and swing away rear pad mounting with the anterior pad on a free swinging hinge. Rear pad may be curved for close client fit. An anterior trunk support strap closes the pads. Micro sizes have a single slotted connecting pad bracket. Client trunk width and depth should be taken to assure proper fit. Please specify all pad sizes. Brackets are available in L, 1" or 2" offset, please specify. Solid back mount



EE5M-STD	Standard 4# foam
EE5M-SUN	Medium Sunmate
EE5M-T-FOAM	Medium T-Foam
EE5M-THIN	Thin foam / ABS
EE5M-TR-STD	Standard 4# foam with tracks
EE5M-TR-SUN	Med Sunmate with tracks
EE5M-TR-T-FOAM	Med T-Foam with tracks
EE5M-TR-THIN	Thin foam with tracks / ABS
EE5M-STD-MICRO	Standard 4# foam—Micro
EE5M-SUN-MICRO	Medium Sunmate foam—Micro
EE5M-T-FOAM MICRO	Medium T-Foam—Micro
EE5M-THIN MICRO	Thin Foam—Micro / ABS
EE5M-TR-STD MICRO	Std 4# foam/ tracks—Micro
EE5M-TR-SUN MICRO	Med Sunmate / tracks—Micro
EE5M-TR-T-FOAM MICRO	Med T-Foam / tracks—Micro
EE5M-TR-THIN MICRO	Thin foam / tracks—Micro/ ABS



EE5P Swing Away Lever Release Thoracic

This hardware has a lever release that is on the underside of the hardware. The hardware lifts and swings away, aiding in ease of transfer and returning to the original position when locked into place. Pads come curved unless otherwise specified. Hardware is available in L-bracket, 1" or 2" offsets, please specify. Dual slotted hardware allows for ample adjustment. Micro sizes have a single slotted connecting pad bracket. Solid back mount.

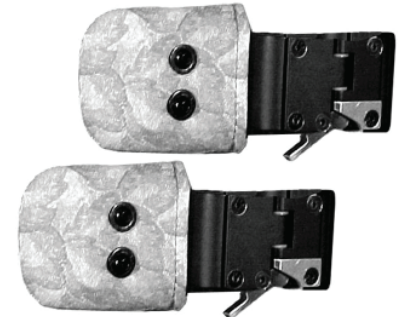

- | | |
|-----------------------------|--------------------------------------|
| EE5P-STD | Standard 4# foam |
| EE5P-SUN | Medium Sunmate |
| EE5P-T-FOAM | Medium T-Foam |
| EE5P-THIN | Thin foam / ABS |
| EE5P-TR-STD | Standard 4# foam with tracks |
| EE5P-TR-SUN | Med Sunmate with tracks |
| EE5P-TR-T-FOAM | Med T-Foam with tracks |
| EE5P-TR-THIN | Thin foam with tracks / ABS |
| EE5P-STD-MICRO | Standard 4# foam—Micro |
| EE5P-SUN-MICRO | Medium Sunmate foam—Micro |
| EE5P-T-FOAM MICRO | Medium T-Foam—Micro |
| EE5P-THIN MICRO | Thin Foam—Micro / ABS |
| EE5P-TR-STD MICRO | Std 4# foam/ tracks—Micro |
| EE5P-TR-SUN MICRO | Med Sunmate / tracks—Micro |
| EE5P-TR-T-FOAM MICRO | Med T-Foam / tracks—Micro |
| EE5P-TR-THIN MICRO | Thin foam / tracks—Micro/ ABS |

EE5Q Swing Away Lever Release Summer/Winter
(hardware and pad included)

These thoracic supports have the ability to laterally swing away from the lateral trunk and be re-engaged at the original position with a lift lever. They can also be laterally quick adjusted with a quarter turn pull pin. Micro sizes have a single slotted connecting pad bracket. There are several no charge foam options for the pads.

Please specify. Solid back mount.



- | | |
|-----------------------|-------------------------------------|
| EE5Q-STD | Standard 4# foam |
| EE5Q-SUN | Medium Sunmate |
| EE5Q-T-FOAM | Medium T-Foam |
| EE5Q-THIN | Thin foam / ABS |
| EE5Q-TR-STD | Standard 4# foam with tracks |
| EE5Q-TR-SUN | Med Sunmate with tracks |
| EE5Q-TR-T-FOAM | Med T-Foam with tracks |
| EE5Q-TR-THIN | Thin foam with tracks / ABS |



EE5Q

Continued

- | | |
|-----------------------------|-------------------------------------|
| EE5Q-STD-MICRO | Standard 4# foam—Micro |
| EE5Q-SUN-MICRO | Medium Sunmate foam—Micro |
| EE5Q-T-FOAM MICRO | Medium T-Foam—Micro |
| EE5Q-THIN MICRO | Thin Foam—Micro / ABS |
| EE5Q-TR-STD MICRO | Std 4# foam/ tracks—Micro |
| EE5Q-TR-SUN MICRO | Med Sunmate / tracks—Micro |
| EE5Q-TR-T-FOAM MICRO | Med T-Foam / tracks—Micro |
| EE5Q-TR-THIN MICRO | Thin foam / tracks—Micro/ABS |



EE5R Lateral Adjustable Growth Thoracic Support Swing Away (hardware and pad included)

These thoracic supports have the ability to laterally swing away from the lateral trunk and be re-engaged at the original position with a lift button. They can also be laterally quick adjusted with a self-locking push pin. There are several no charge foam options for the pads.

- | | |
|-----------------------|-------------------------------------|
| EE5R-STD | Standard 4# foam |
| EE5R-SUN | Medium Sunmate |
| EE5R-T-FOAM | Medium T-Foam |
| EE5R-THIN | Thin foam /ABS |
| EE5R-TR-STD | Standard 4# foam with tracks |
| EE5R-TR-SUN | Med Sunmate with tracks |
| EE5R-TR-T-FOAM | Med T-Foam with tracks |
| EE5R-TR-THIN | Thin foam with tracks |



EE5S Lateral Adjustable Growth Thoracic Support Lever Release

These thoracic supports have the ability to laterally swing away from the lateral trunk and be re-engaged at the original position with a lift lever. They can also be laterally quick adjusted with a self-locking push pin. There are several no charge foam options for the pads.

- | | |
|-----------------------|-------------------------------------|
| EE5S-STD | Standard 4# foam |
| EE5S-SUN | Medium Sunmate |
| EE5S-T-FOAM | Medium T-Foam |
| EE5S-THIN | Thin foam / ABS |
| EE5S-TR-STD | Standard 4# foam with tracks |
| EE5S-TR-SUN | Med Sunmate with tracks |
| EE5S-TR-T-FOAM | Med T-Foam with tracks |
| EE5S-TR-THIN | Thin foam with tracks / ABS |

No Longer Available





EE5T Lateral Depth Adjustable Growth Thoracic Supports (includes hardware and pads)

No Longer Available

These thoracic supports have the ability to laterally swing away from the lateral trunk and be re-engaged at the original position with a lift button. They can also be laterally quick adjusted with a self-locking push pin. They can also be adjusted for depth using an allen wrench. There are several no charge foam options for the pads.



- | | |
|-----------------------|-------------------------------------|
| EE5T-STD | Standard 4# foam |
| EE5T-SUN | Medium Sunmate |
| EE5T-T-FOAM | Medium T-Foam |
| EE5T-THIN | Thin foam / ABS |
| EE5T-TR-STD | Standard 4# foam with tracks |
| EE5T-TR-SUN | Med Sunmate with tracks |
| EE5T-TR-T-FOAM | Med T-Foam with tracks |
| EE5T-TR-THIN | Thin foam with tracks / ABS |

EE5U Lateral Depth Adjustable Growth Thoracic Supports Lever Release (includes hardware and pads)

No Longer Available

These thoracic supports have the ability to laterally swing away from the lateral trunk and be re-engaged at the original position with a lift lever. They can also be laterally quick adjusted with a self-locking push pin. They can also be adjusted for depth using an allen wrench. There are several no charge foam options for the pads.

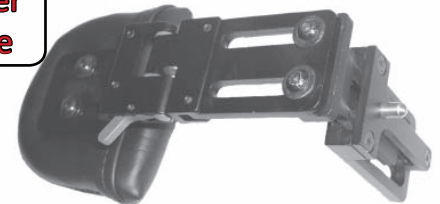

- | | |
|-----------------------|-------------------------------------|
| EE5U-STD | Standard 4# foam |
| EE5U-SUN | Medium Sunmate |
| EE5U-T-FOAM | Medium T-Foam |
| EE5U-THIN | Thin foam / ABS |
| EE5U-TR-STD | Standard 4# foam with tracks |
| EE5U-TR-SUN | Med Sunmate with tracks |
| EE5U-TR-T-FOAM | Med T-Foam with tracks |
| EE5U-TR-THIN | Thin foam with tracks / ABS |



Mod-5B Breast Relief Cut Outs

This modification tapers the top edge of the pad to aid in comfort for females with breast tissue. May also be used to taper flat pads for better range of motion in the upper extremities. Standard sizes are available, based on pad size or you may specify requirements.



Mod-5E Roll Over Pads

These pads have a thin layer of foam with fabric cover to add extra padding and protection to the lateral support pads. Attaches with 1" webbing and double D-ring.



Mod-5F Protective Boots

Designed to slip over the trunk support hardware to protect client from metal. Pads are made of soft stretch fabric chosen for it's wear and comfort. These can be made in colored Lycra/Neoprene if requested. Not recommended in naugahyde, nylon or cordura.



Mod-5G Thoracic Support Pads Only

Replacement pads for existing hardware are available with this modification. You may order standard flat or standard curved pads or specify dimensions. Thin profile available upon request. Pads will come with t-nuts for Freedom Designs, Inc. hardware.



- MOD-5G-STD**
- MOD-5G-SUN**
- MOD-5G-T-FOAM**
- MOD-5G-THIN**

- Standard 4# Foam**
- Medium Sunmate**
- Medium T-Foam**
- Thin Foam / ABS**



Mod-5J Extension Brackets

Longer brackets may be needed when using a back that is thicker than the Freedom Designs, Inc. standard back of 1 1/2" total thickness. When ordering the back and hardware at the same time, correct length brackets will be sent. When ordering for retrofit, please specify total back thickness and type of hardware.



Mod-5K Thin Profile Pads

Thin profile pads are available on any lateral thoracic support assembly. Pads are 1/4" ABS base with 1/4" high density neoprene foam. Total thickness. Including upholstery cover, averages 3/4".



Mod-5L Lateral Thoracic Support Upholstery Cover Only

This modification can be used to order upholstery for existing pads or when returning pads for recover to our factory. (Must have a valid Return Authorization #). When ordering pad covers only, please provide all dimensions or original order information. Cover sent will require staple closure. Can order hook & loop closure at no additional charge. Solid back mount.

Mod-5M Contour Fit Lateral Pads

This is a modification to the trunk pads where the posterior (rear) part of the pad is larger and slightly curved to capture the posterior lateral portion of the trunk.





The Standard Anterior Shoulder Support Retractor/Straps

Through input from the field, we are able to provide a diversity of anterior shoulder support straps suitable for all positioning requirements. All straps have adjustable nylon webbing with squeeze side release buckles. Standard sizes are available, based on sitting surface to top of shoulder height. Custom shoulder straps are available, built to your specifications when you provide a diagram.

Designed to mount to a solid back for the following part numbers:

EE6G, EE6I, EE6J, EE6L, EE6M & EE6N

Standard sizes are as follows:

SMALL	9" - 14" SITTING HEIGHT
MEDIUM	14" - 20" SITTING HEIGHT
LARGE	20" - 28" SITTING HEIGHT

The Standard Anterior Trunk Support Vest/Harness

Freedom Designs, Inc. has incorporated into our product line many styles of vests to meet your clients needs. Anterior support vest sizing is based on chest width. All vests can be made to your specifications when you provide a diagram.

Plastic squeeze side release buckles come standard for ease of transfer with adjustable webbing to ensure proper fit.

Designed to mount to a solid back for the following part numbers:

EE6C, EE6D, EE6K, EE6P, EE6Q & EE6R

Standard sizes are as follows:

X-SMALL	8" CHEST WIDTH
SMALL	10" CHEST WIDTH
MEDIUM	13" CHEST WIDTH
LARGE	15" CHEST WIDTH

The Standard Anterior Trunk Support Strap

Freedom Designs, Inc. offers a wide variety of anterior trunk support straps. Strap sizes are general, based on chair width. All straps can be made to your specifications when you provide a diagram. Plastic squeeze release buckles come standard for ease of transfer, with adjustable webbing to ensure proper fit.

Designed to mount to a solid back for the following part numbers:

EE6G, EE6I, EE6J, EE6L, EE6M & EE6N

Standard sizes are as follows:

SMALL	12" - 14" SITTING HEIGHT
MEDIUM	14" - 16" SITTING HEIGHT
LARGE	16" - 18" SITTING HEIGHT



106-2000 Shoulder Retractor Straps

These straps are designed to fit the client under the axilla and over the acromion process. Straps come with 1" webbing as standard, other webbing sizes are available upon request. Squeeze side release buckles above the shoulder helps ease of transfer. Padding placement is adjustable on webbing. Hook & loop adjustment guides behind the neck aid in proper strap placement. Pads are 5# foam with your choice of upholstery. Straps are static. Solid back mount.



EE6B Upper Trunk Support System/H-Strap

Designed for shoulder retraction and upper trunk support. This system offers adjustable shoulder straps attached to anterior trunk support straps. (This is not a hip belt). Shoulder straps use 1" webbing. Trunk support strap has 2" webbing. Padding is 5# foam with your choice of fabric. Custom H-strap available when you provide a diagram. Standard sizes are based on sitting height to top of shoulder. Solid back mount



106-5000 Shoulder Support Pads—Lift & Swing Away Hardware with Flat Oval Pads

Designed for vertical and horizontal adjustment. The pads lift and swing away to the side, when released. A universal ball joint ensures precise pad location for optimal positioning and pressure relief.

Standard sizes are as follows:

SMALL	2 1/2" W X 3" H
MEDIUM	2 1/2" W X 4" H
LARGE	2 1/2" W X 5" H



106-5000A Shoulder Support Pads—Lift & Swing Away Hardware with Cylindrical Contoured Pad

These pads have lift and swing away hardware. Padded above and below the bend, these tubular shaped pads offer both anterior and superior shoulder control capabilities. Please specify pad depth (Above the bend) and pad length (below the bend). Bars come bent at 70° standard, but special bends are available upon request at no additional charge.





EE6C Butterfly Chest Vest

Designed for shoulder support and anterior trunk support. The vest features a padded center piece in your choice of fabric. Squeeze release buckles on all four straps provide quick on and off. Adjustable 1" webbing allows for accurate fit. Padding is movable for added client comfort. Available with dynamic shoulder straps upon request. Sizing is based on client chest width. Solid back mount.



EE6D Butterfly Chest Vest

Designed for shoulder and anterior trunk support. These vests feature a hook & loop attachment for multiple mounting options. May be mounted to a sling back chair when back posts are used for securing the vest. Standard sizes are based on chest width.



EE6E Chest Strap

This strap is constructed of fabric only. Overlapping hook & loop closure provide adjustable fit. May be mounted to the back post with snap closure or mounted to the solid back with grommet ends, please specify. Length is based on chair width. Standard height is 3"; other heights are available upon request.



EE6G V-Harness

The V-harness has shoulder retraction straps with movable padding and hook & loop width guides. Straps are joined together with dual receiver push button buckle. A webbing loop below the push button buckle attaches to any hip belt. Standard sizes are based on sitting height to top of shoulder.





EE6H Upper Torso Strap

The strap provides anterior trunk support. Made of 2" nylon webbing, this strap can attach to back posts or a solid back. Overlapping hook & loop closure is sewn to light weight nylon fabric. This light weight nylon strap is quick to dry, making it perfect for shower chair applications. Squeeze release buckle bilaterally helps keep hook & loop adjustment the same and aid in ease of transfer. Standard sizes are based on chair width.

No Longer Available



EE6I CAP Straps

No Longer Available

Clavicular Acromion Process straps attach to the solid back and the lateral support pads. They aid in shoulder retraction and provide maximum upper trunk support. Dynamic inner pads and static outer pad are sewn together at trunk support and are width adjustable for exact placement at the shoulder. Straps are sold in pairs (right only shown) Both straps.



EE6J Dynamic Shoulder Straps

Designed to provide shoulder retraction, these straps afford positioning with dynamic movement. 1" webbing is attached to a plush lycra pad. The pad is integrated to the webbing. Extension and flexion are accommodated by the stretch of the plush lycra pad. Hook & loop width adjustment strap facilitates optimal placement. Custom straps available in all webbing sizes upon request. Standard sizing is based on sitting height to top of shoulder. There is no fabric or color choice when plush lycra is used. Pads are black. Solid back mount.



EE6K ABS Chest Vest

No Longer Available

This chest vest is designed to give support, stability and assistance in trunk alignment. A thin piece of ABS is covered in your choice of padded fabric. Extra small webbing in 1/2" is available with 3/4" buckles to fit your tiniest positioning needs. Standard sizing is based on chest width. Solid back mount.





EE6L Anterior or Posterior Pull Harness

This anterior/posterior pull harness provides a choice of directional pull. The harness can be ordered with anterior pull (standard if not specified), the adjustment is on the front of the straps or posterior pull (must be specified) with the adjustment on the back of the solid back. Squeeze release buckles with 1" webbing straps have nylon pads sewn to the straps to ensure correct placement. A small squeeze release buckle width adjustment strap at the sternum assures strap angle and position won't change. Solid back mount



EE6M CAP Strap "Guba" Style

No Longer Available

Clavicular Acromion Process straps that attach to the solid back and lateral trunk support pads. Y-shaped pad directs a dynamic strap over the Acromion Process while the static inside strap contacts the clavicle. All straps are 1" webbing with squeeze release buckles. A hook & loop width adjustment strap ensures correct placement. Sizing is based on sitting height to top of shoulder. Solid back mount

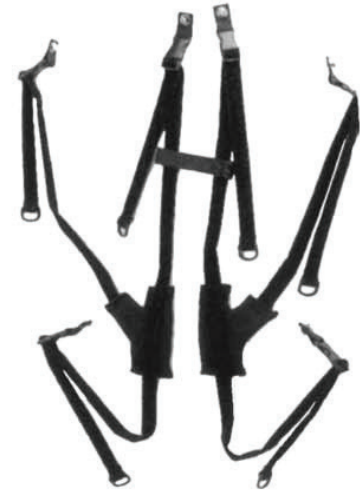

EE6N Dynamic Anterior or Posterior Pull

This anterior/posterior pull harness provides a choice of directional pull. The harness can be ordered with anterior pull (standard if not specified), with the adjustment on the front on the straps or posterior pull (must be specified) with adjustment on the back of the solid back. Squeeze release buckles with 1" webbing straps have dynamic plush lycra pads integrated into the straps. A small squeeze release buckle with adjustment strap at the sternum assures strap angle and position won't change. Extension and flexion are accommodated by the stretch of the plush lycra pad. There is no color or fabric choice when dynamic material is used. Pads are black. Standard sizing is based on sitting height to top





EE6P Butterfly Chest Vest with Swivel Mounted

Designed for shoulder retraction and anterior trunk support. The padded center comes in your choice of fabric (stretch fabric is recommended). 1" webbing straps are attached to the center pad with angle adjustable swivels. Swivels allow for greater control of strap placement. Shoulder straps have movable pads in 5# foam. Dynamic shoulder pads are available upon request. All four straps have squeeze release buckles for ease of transfer. Standard sizing is based on chest width. Custom vest available when you provide a diagram. Solid back mount



EE6Q Clear Chest Vest

This chest vest is constructed of 1/4" clear soft plastic with 1" webbing and four squeeze release buckles. Straps are mounted to the vest with swivels. Designed to have the clear material to the top on the shoulders, there are no pads at the shoulders. There is no color choice with a clear vest. Standard sizing is based on chest width. Custom vest available when you provide a diagram. Solid back mount.



EE6R Dynamic Thoracic Support Vest

The vest is constructed of 1" webbing and the body is entirely lycra. Vest extends its plush lycra dynamic stretch up and over the shoulders. This one piece design accommodates flexion and extension of the entire upper torso. Squeeze release buckles at all four strap ends allow for quick on and off. There is no color or fabric choice when dynamic material is used. Vest will be black. Standard sizing is based on chest width. Solid back mount.



EE6S X Chest Vest

This vest is in the shape of an X for support as well as easy fitting for the client. This chest vest is made of plush lycra in the X area and webbing on the straps. 1" webbing is used for the straps with buckle release. Standard sizing is based on chest width. Solid back mount.





EE6T Velcro Chest Vest

Vest straps come in 1" soft black Velcro and come with mounting hardware to secure to a solid back. Shoulder straps have movable pads in 5# foam. Dynamic pads are available upon request. Standard sizing is based on chest width. Solid back mount.

No Longer Available



EE6U Velcro Chest Vest

Vest straps come in 1" soft black Velcro and come with mounting hardware to secure to a solid back. Shoulder straps have movable pads in 5# foam. Dynamic pads are available upon request. Standard sizing is based on chest width. Solid back mount.



EE6V Freedom Form Vest

This anterior chest support is a traditional stretching style chest vest that is shaped to accommodate a developing female.



EE6W Width Adjustable Chest Vest—Static

This anterior chest support is a traditional non-stretching style chest vest split down the middle. The two halves are reconnected with hook & loop or buckles to achieve the desired width on the anterior trunk, or proper input angle at the clavicle. It also allows the client or caregiver to undo the vest from the front.



EE6W-B Width Adjustable Chest Vest—Static with Buckle Closure

Identical to the EE6W but with additional buckle closure.



EE6W-D Width Adjustable Chest Vest—Dynamic

This anterior chest support is a traditional stretching style chest vest split down the middle. The two halves are reconnected with Velcro or buckles to achieve the desired width on the anterior trunk, or proper input angle at the clavicle. It also allows the client or caregiver to undo the vest from the front.

EE6W-DB Width Adjustable Chest Vest—Dynamic with Buckle Closure

EE6X Tapered A.P. Harness

This is a harness that has “boomerang” shaped pads that contact the anterior trunk and the clavicle. There is an adjustment strap that connects the two pads with a fastex buckle release.



EE6Y Width Adjustable Chest Vest Butterfly Style—Static

This anterior chest support is a traditional butterfly shaped style chest vest that is split down the middle. The two halves are reconnected with Velcro or buckles to achieve the desired width on the anterior trunk, or proper input angle at the clavicle. It also allows the client or caregiver to undo the vest from the front.

No Longer Available

EE6Y Width Adjustable Chest Vest Butterfly Style—Static with Buckle Closure

No Longer Available

EE6Y-D Width Adjustable Chest Vest Butterfly Style - Dynamic

No Longer Available

This anterior chest support is a traditional butterfly shaped stretching style chest vest that is split down the middle. The two halves are reconnected with hook & loop or buckles to achieve the desired width on the anterior trunk, or proper input angle at the clavicle. It also allows the client or caregiver to undo the vest from the front.

EE6Y-D Width Adjustable Chest Vest Butterfly Style - Dynamic with Buckle Closure

No Longer Available





Mod-6A Strap Risers - Straight

This hardware is designed to hold shoulder straps in place. Mounting to the top of the solid back, these flat strap risers keep the webbing in position.



Mod-6B Strap Risers—25° Bend

This hardware is designed to hold the shoulder strap in place. These risers offer a 25° bend allowing the hardware to be placed down below the top of the back. These bent strap risers hold the webbing in place.



Mod-6C Replacement Shoulder Pads

Use this modification when ordering replacement pads for shoulder straps that have movable padding. When ordering replacement pads, please specify webbing width, pad length and upholstery color.



Mod-6D Left or Right G Tube Cut Out

Use this modification when a cut out for a G tube is needed in the chest vest. Please specify size of cut out needed and which side the cut out is on.



Mod-6E Reinforcement to any Chest Vest

Use this modification when additional strength / support is needed for a chest vest, or to limit the amount of stretch on a dynamic vest.



The Standard Headrest Pad

Freedom Designs, Inc. offer a wide variety of head support pads and hardware combinations to meet your positioning needs. Standard construction is difficult, with such a wide range of styles. Each "a la carte" pad description will denote the construction of the pad and foam type. Some pads are available in standard sizes, while with other pads you will need to call out all dimensions. This will also be noted in the "a la carte" section, along with fabric restrictions, where applicable. Hardware mounting restrictions will be noted under "a la Carte" hardware descriptions. Standard sizing is based on head circumference (where available)

Custom sizes are available when you provide a diagram.

Standard sizes for a 7750 are as follows:

<i>SMALL</i>	<i>18" Circumference</i>
<i>MEDIUM</i>	<i>20" Circumference</i>
<i>LARGE</i>	<i>23" Circumference</i>
<i>X-LARGE</i>	<i>25" Circumference</i>

Standard pad sizes for a 7750 are as follows:

<i>SMALL</i>	<i>Outside of curve</i>	<i>11"</i>
	<i>Width across front</i>	<i>5"</i>
	<i>Height</i>	<i>3 3/4"</i>
<i>MEDIUM</i>	<i>Outside of curve</i>	<i>11"</i>
	<i>Width across front</i>	<i>6"</i>
	<i>Height</i>	<i>3 3/4"</i>
<i>LARGE</i>	<i>Outside of curve</i>	<i>12"</i>
	<i>Width across front</i>	<i>6 1/2"</i>
	<i>Height</i>	<i>4"</i>
<i>X-LARGE</i>	<i>Outside of curve</i>	<i>12"</i>
	<i>Width across front</i>	<i>7 1/2"</i>
	<i>Height</i>	<i>4"</i>



Standard pad sizes for a 7751 are as follows:

<i>SMALL</i>	<i>Outside end to end</i>	<i>15"</i>
	<i>Width across opening</i>	<i>3"</i>
	<i>Height in rear</i>	<i>5"</i>
	<i>Height at sides</i>	<i>2"</i>
<i>MEDIUM</i>	<i>Outside end to end</i>	<i>20"</i>
	<i>Width across opening</i>	<i>4"</i>
	<i>Height in rear</i>	<i>5"</i>
	<i>Height at sides</i>	<i>2"</i>
<i>LARGE</i>	<i>Outside end to end</i>	<i>22"</i>
	<i>Width across opening</i>	<i>6"</i>
	<i>Height in rear</i>	<i>6"</i>
	<i>Height at sides</i>	<i>2"</i>

Standard pad sizes for 7757 are as follows:

<i>SMALL</i>	<i>Outside of curve</i>	<i>13"</i>
	<i>Width across front</i>	<i>8 1/2"</i>
	<i>Center height</i>	<i>3 1/2"</i>
	<i>Side wing height</i>	<i>2"</i>
	<i>Inside depth</i>	<i>3 1/2"</i>
	<i>Inside width</i>	<i>3"</i>
<i>MEDIUM</i>	<i>Outside of curve</i>	<i>14"</i>
	<i>Width across front</i>	<i>9"</i>
	<i>Center height</i>	<i>4"</i>
	<i>Side wing height</i>	<i>2"</i>
	<i>Inside depth</i>	<i>3 1/2"</i>
	<i>Inside width</i>	<i>3 1/2"</i>
<i>LARGE</i>	<i>Outside of curve</i>	<i>16"</i>
	<i>Width across front</i>	<i>13"</i>
	<i>Center height</i>	<i>4"</i>
	<i>Side wing height</i>	<i>2"</i>
	<i>Inside depth</i>	<i>3 1/2"</i>
	<i>Inside width</i>	<i>4 1/2"</i>



Standard pad sizes for 7758 are as follows:

X-SMALL	center 4w x 3h / sides 4w—2-1
SMALL	center 5w x 4h / sides 4w—3 1/2-2
MEDIUM	center 5w x 4h / sides 5w—3 1/2-2
LARGE	center 6w x 5h / sides 6w—4-2

A La Carte Head Rest Pads

Following the “a la carte” head support pads, you will find a description of your choices in mounting hardware “a la carte”.

7750 Slight Curve Headrest

The pad is constructed of 1/4” kydex base with 1” of 5# foam, with your choice of upholstery fabric. Standard sizes are available. To order custom sizes, please provide dimensions. Length around rear of pad x Height of Pad x Opening across face of pad. This pad offers minimal head control in standard configuration.



7750-STD	Standard 4# foam
7750-SUN	Medium Sunmate
7750-T-FOAM	Medium T-Foam

7751 Curved Pad with Occipital Ledge and Lateral Neck Support

The headrest features lateral and posterior neck support with an occipital ledge for additional head support. ABS shell slides into covered 5# foam pad. Foam on neck support extends beyond ABS shell for client comfort. Standard sizing is available, based on head circumference. Custom pads may be ordered when you provide all required dimensions or a diagram. When ordering a custom pad, please give length of pad when measured around the rear, height of pad, width of the opening across the front of the pad and length of lower neck support.



7751-STD	Standard 4# foam
7751-SUN	Medium Sunmate
7751-T-FOAM	Medium T-Foam



7752 Three Piece Pad—Fixed

The pads have an exterior ABS shell with 3 pads of 1" 4# foam attached to the shell with hook & loop. There are no standard sizes for this pad style. You must specify dimensions of all three pads. ABS shell comes standard with a 120° bend of the side pads. Custom bends are available upon request. Your choice of any fabric may be used. In standard configuration, this pad provides moderate head control.

Standard Sizes: Small 4" x 4" Medium 5" x 4" Large 5" x 5"

7752-STD	Standard 5# foam
7752-SUN	Medium Sunmate
7752-T-FOAM	Medium T-Foam



7753 Three Piece Pad—Hinged Adjustable

This headrest pad features three separate pads. A 1/4" ABS base with 1" of 4# foam makes up the pad construction. The center pad has side pads attached with adjustable hinges. The pad is designed to aid in control of ATNR and to add extra support for clients with poor head control. When ordering pads of differing heights, please specify alignment.

Standard Sizes: Small 4" x 4" Medium 5" x 4" Large 5" x 5"

7753-STD	Standard 5# foam
7753-SUN	Medium Sunmate
7753-T-FOAM	Medium T-Foam

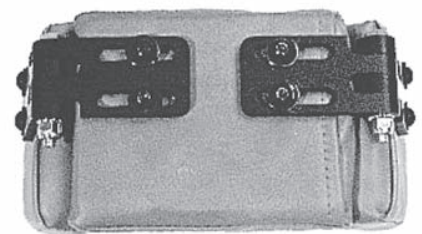

7754 Molded Headrest Pad

This is a two step pad with molded occipital shelf. This pad can only be mounted on ball and socket style hardware.

Available in two standard sizes.

SMALL	PEDIATRIC 12" W X 4" H
LARGE	ADOLESCENT/ADULT 14" W X 5 1/2" H





7755 Headrest Extension Pad

This pad is constructed of 1/2" marine grade plywood and 1" of 4# foam. There are no standard sizes for this pad. Please provide width and height dimensions.

- 7755-STD Standard 5# foam**
- 7755-SUN Medium Sunmate**
- 7755-T-FOAM Medium T-Foam**



7756 Chubbie Headrest Pad

This oval shaped curved headrest has a 1/4" ABS base. The layers of foam are flared to ensure client protection. 1" of 10# foam is the base with an additional 1" of 3# foam on the top. The face of the pad is larger than the ABS base. Pads come standard in black lycra. Other stretch fabrics may be specified. Naugahyde, nylon and cordura are not recommended.

The Chubbie comes in three standard sizes:

- SMALL** 10W X 4 1/2H
- MEDIUM** 12W X 4 1/2H
- LARGE** 13 1/2W X 4 1/2H



7757 Low Profile Occipital Head Support Pad

This pad is designed to cradle the occipital area, while offering lateral head support. A 1/4" ABS base is curved to provide comfortable support of the occiput. The tapered pad continues down while flaring out to provide support for the neck. The occipital ledge is formed with 1/2" of 4# foam and 1/2" of 3# foam, which covers the entire top contact surface. Please provide a size: Small, Medium or Large



7758 Hinged Headrest with Ear Cut-outs

This headrest pad features three separate pads. A 1/4" ABS base with 1" medium Sunmate foam makes up the pad construction. The slightly curved center pad has side pads attached with adjustable hinges. The slightly curved side pads have ear cut-outs. This pad is designed to aid and control ATNR and to add extra support for clients with poor head control while allowing ear relief. Pad styles come in small, medium and large sizes or customize your own by specifying dimensions of all three pads and ear cut-outs. When ordering pads of differing heights, please specify alignment. Custom foams are also available.





7759 Dynamic Headrest

This headrest pad is a rectangular shape with a phenolic base. Attached to the base are 4 springs which allow dynamic support . The pad consists of 1/2" wood base with build-ups of 3" 5# foam on the sides, tapering to 2 1/2" of 5" foam in the center. Custom foams are available with your choice of upholstery cover. Please provide dimensions. Mounting hardware is only available with 2 each #7700. This pad offers dynamic head control with comfort. Please provide width and height of pad.

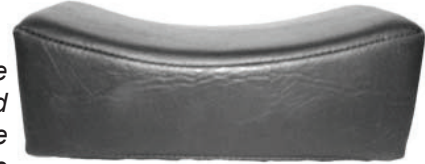

7760 Skinny Headrest Pad

This oval shaped pad has a 1/4 ABS base with 1/2" medium summate foam. The foam is rolled over the edges of the base for skin protection. Zippers allow foam access.

(Face of pad measurements)

- SMALL 8W X 4.5H
- MEDIUM 10W X 4.5H
- LARGE 12W X 4.5H
- X-LARGE..... 14W X 4.5H
- CUSTOM SPECIFY



7761 High Profile Neck / Headrest Support

Pad: This pad has a 1/4" ABS base with 1/2" medium summate foam. There is a tall posterior section and well defined occipital ledge. The foam is rolled over the edges of the base for skin protection. Zippers allow foam access.

(Face of pad measurements)

- XSMALL 5.5W X 6H
- SMALL 5.75W X 6.5 H
- MEDIUM 6.5W X 7.5H
- LARGE..... 7W X 8H
- CUSTOM SPECIFY



7762 Molded Occipital Lateral Headrest

This is a pre-molded pad that has a defined occipital ledge and support "wings" at the top of the pad. There is an internal bendable metal that allows custom fitting of the "wings". Pad can only be used with ball and socket hardware.

*Face of pad measurements:
(one size only)*

- Height..... 7"
- Lower Width..... 6"
- Top "Wing" Width (Bendable).... 7"-14"
- Wing Depth..... 6"
- CUSTOM..... Not Available





A LA CARTE HEADREST HARDWARE

7700 Vertical and Depth Adjustable Hardware

This hardware offers star knob release, vertical removal and height adjustment. Anterior and posterior adjustment is also integrated into this hardware. Hardware cannot mount on 7754 style pad.

7701 Multi-Adjustable Removable Hardware

This hardware features a ball and socket style pad mounting. The ball end allows for unlimited pad positioning while the long rod gives ample anterior adjustment. Height adjustment is provided by a pull knob release that makes it able to be removed.

7702 Flip Back Hardware—Short Post Axial Mount

The hardware offers a pull knob release that allows the pad to flip back out of the way when not in use. Flip back hardware is mounted to a vertically placed track for easy height adjustment. Hardware cannot mount on 7754 style pad.

7703 Flip Back Hardware—Long Post—Multi Axial Mount

The hardware offers a pull knob release that allows the pad to flip back out of the way when not in use. Flip back hardware is mounted to a vertically placed track for easy height adjustment. The hardware has the multi axial ball and socket pad mount with long horizontal rod for unlimited pad positioning.

7704 Pull Knob Quick Release Hardware

The hardware is pull knob adjustable in height as well as removable. Posterior and anterior adjustment is incorporated into this hardware. Hardware cannot mount on 7754 style pad.





7706 Slide Lock Flip Back Hardware

This bracket has anterior and posterior adjustment with a gravity lock one step flip down mechanism. A vertically mounted track gives non-incremental height adjustment. Hardware cannot mount on 7754 style pad.

7707 Slide Lock Flip Back Hardware—Multi Adjustable

This hardware has a long anterior and posterior adjustment rod with a ball and socket pad mounting. A gravity lock, one step flip down mechanism, allows the pad to flip out of the way when not in use. A vertically mounted track gives non-incremental height adjustment.

7708 Rock and Roll Headrest

This hardware has 3 “knuckle” joints that allow multi-axial adjustment in the mid-sagittal plane, without the bulk of a ball and socket rod. All Freedom pads will interface except 7754 & 7763. There is a wood screwed, lateral track that allows non-incremental placement at set up. This hardware is removable.

7709 Rock and Roll Flip Back Headrest

This hardware has 3 “knuckle” joints that allow multi-axial adjustment in the mid-sagittal plane, without the bulk of a ball and socket rod. All Freedom pads will interface except 7754 & 7762. There is a wood screwed lateral track that allows base placement off of mid-line. This hardware has a one-hand release flip down function, and a self-locking reengagement mechanism. There is a wood screwed, vertical track that allows non-incremental placement at set up.



HEADREST MOUNTING PLATES

7730 Universal Headrest Mounting Plate

This plate is designed to mount other manufacturer’s head supports. The plate can be mounted directly to the back when back is constructed or you may retrofit it to an existing back with dual slotted tracks. Mounts Whitmyer, Ottobock and Miller Headrests.



7731 Freedom Headrest Mounting Plate

This plate is designed to mount selected Freedom Designs, Inc. head supports. The plate can be mounted directly to the back when the back is being fabricated or retrofit after construction with dual slotted track. Mounts Freedom Designs, Inc. headrest assemblies EE7A, EE7B, EE7C, EE7I, 107-8000 and Freedom Designs, Inc. headrest mounting hardware 7700, 7701 and 7704. This can be used as an abductor plate.





HEADREST SUPPORT PAD AND HARDWARE COMBINATIONS

107-1000 Vertically Adjustable Neck/Head Support

Pad: 7751 Curved Pad with Occipital Ledge
Hardware: 7700 Vertically and Depth Adjustable Hardware

107-1000-STD **Standard 4# foam**
107-1000-SUN **Medium Sunmate**
107-1000-T-FOAM **Medium T-Foam**



EE7A Vertical and Horizontal Adjustment Head Support

Pad: 7750 Slight Curve Pad
Hardware: 7700 Vertically and Depth Adjustable Hardware

EE7A-STD **Standard 4# foam**
EE7A-SUN **Medium Sunmate**
EE7A-T-FOAM **Medium T-Foam**



EE7B Multi-Adjustable Neck/Head Support

Pad: 7751 Curved Pad with Occipital Ledge and Lateral Neck Support
Hardware: 7701 Multi-Adjustable Removable Hardware

EE7B-STD *Standard 4# foam*
EE7B-SUN *Medium Sunmate*
EE7B-T-FOAM *Medium T-Foam*



EE7C Three Piece Headrest

Pad: 7752 Three Piece Pad—Fixed
Hardware: 7700 Vertically and Depth Adjustable Hardware

EE7C-STD **Standard 4# foam**
EE7C-SUN **Medium Sunmate**
EE7C-T-FOAM **Medium T-Foam**





EE7E Hinge Lock Headrest

Pad: 7753 Three Piece Pad—Hinged Adjustable
Hardware: 7700 Vertically and Depth Adjustable Hardware

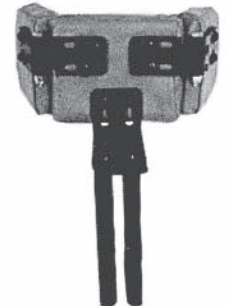

- EE7E-STD** **Standard 4# foam**
- EE7E-SUN** **Medium Sunmate**
- EE7E-T-FOAM** **Medium T-Foam**

EE7F Multi-Adjustable Neck Collar

Pad: Semi Circular Neck Collar Available In SMALL, MEDIUM and LARGE
Hardware: 7700 Vertically and Depth Adjustable Hardware



EE7G Multi-Adjustable Neck Collar
(Previously EE7G-2)

Pad: 7751 Curved Pad with Occipital Ledge and Lateral Neck Support
Hardware: 7702 Flip Back Hardware—Short Post



- EE7G-STD** **Standard 4# foam**
- EE7G-SUN** **Medium Sunmate**
- EE7G--FOAM** **Medium T-Foam**

EE7H Molded Flip Back

Pad: 7754 Molded Headrest Pad
Hardware: 7703A or 7703-2 Flip Back Hardware—Long Post— Multi Axial Mount



No Longer Available



EE7I Pull Knob Quick Release

Pad: 7750 Slight Curve Pad
 Hardware: 7704 Pull Knob Quick Release Hardware

EE7I-STD Standard 4# foam
 EE7I-SUN Medium Sunmate
 EE7I-FOAM Medium T-Foam



EE7K Adjustable Padded Neck Collar

Designed to provide neck, head and anterior trunk support. This collar is all 5# foam with your choice of upholstery fabric and color. Measurements are critical to client comfort and safety. Please contact our customer service department for a diagram to fill in, to ensure your product fit and comfort.



EE7L Positioning Cap

The halo strap has been securely attached to the inside of a Freedom Designs, Inc. ball cap. This camouflage makes the strap less obvious, allowing for greater self-confidence in the user. Posterior pulley ropes yield greater positioning of the cap, when used in conjunction with a Whitmyer headrest. Please provide head circumference to ensure proper fit. Two sizes are available: YOUTH and ADULT

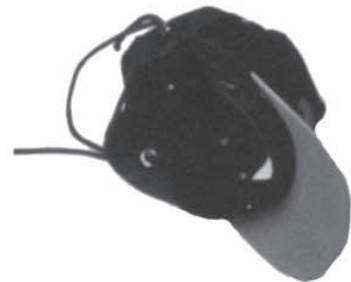

EE7N Slide Lock Flip Headrest

Pad: 7750 Slight Curve Pad
 Hardware: 7706 Slide Lock Flip Back Hardware





EE7P Chubbie Multi-Adjustable Flip Headrest

Pad: 7756 Chubbie Headrest Pad
 Hardware: 7703 Slide Lock Flip Back Hardware—Long Post—Multi Axial Mount



EE7Q Low Profile Neck/Head Support

Pad: 7757 Low Profile Occipital Head Support Pad
 Hardware: 7703A Flip Back Hardware—Long Post—Multi Axial Mount



107-4000 Halo Strap

Designed to mount to the headrest pad for maximum head control. Please specify head circumference. Comes standard with 1" webbing and movable padding, in your choice of fabric and color. Will not work with our molded headrest part # 7754.



107-5000 Hard Halo

Designed to mount to a solid back, this traditional style halo provides rigid support for maximum head control. Padded with 5# foam and your choice of fabric and color. Please specify head circumference.



107-8000 Headrest Extension

Pad: 7755 Headrest Extension Pad
 Hardware: 7700 Vertically and Depth Adjustable Hardware



- 107-8000-STD Standard 4# foam**
- 107-8000-SUN Medium Sunmate**
- 107-8000-T-FOAM Medium T-Foam**



EE7R Skinny Headrest Pad / Adjustable Flip Hardware

Pad: 7760 Skinny: This oval shaped pad has a ¼ ABS base with 1/2” medium summate foam. The foam is rolled over the edges of the base for skin protection. Zippers allow foam access.



(Face of pad measurements)

SMALL	8W X 4.5H X 2.5D
MEDIUM	10W X 4.5H X 2.5D
LARGE	12W X 4.5H X 2.5D
X-LARGE	14W X 4.5H X 2.5D
CUSTOM	SPECIFY

Hardware: 7703 or 7703A: Silver cylinder release mechanism, side mounted. Flip down hardware with multi axial adjustment.

EE7S High Profile Neck / Headrest Support

Pad: This pad has a 1/4” ABS base with 1/2” medium summate foam. There is a tall posterior section and well defined occipital ledge. The foam is rolled over the edges of the base for skin protection. Zippers allow foam access.



(Face of pad measurements)

XSMALL	5.5W X 6H
SMALL	5.75W X 6.5 H
MEDIUM	6.5W X 7.5H
LARGE	7W X 8H
CUSTOM	SPECIFY

Hardware: 7703 or 7703A: Silver cylinder release mechanism, side mounted. Flip down hardware with multi axial adjustment.

EE7T Rock and Roll Headrest—Complete

Pad: 7756 Chubbie: This oval shaped pad has a ¼ ABS base with 1” of 10# foam and an additional 1” of 3# foam on top. The foam is rolled over the edges of the base for skin protection. Zippers allow foam access.

Hardware: 7708 Rock and Roll: Multiple axial adjustments, height adjustable and removable. Lateral wood screw track standard.



(Face of pad measurements)

SMALL	8W X 4.5H X 2.5D
MEDIUM	10W X 4.5H X 2.5D
LARGE	12W X 4.5H X 2.5D
X-LARGE	14W X 4.5H X 2.5D
CUSTOM	SPECIFY



EE7U Spring Loaded Pad with Hardware

Pad: 7759 Dynamic Headrest Pad
Hardware: 7732 There is a pair of #7700 (vertical/depth adjust) hardware which is required to properly support the dynamic pad.



(Face of pad measurements)

- SMALL 6W X 4.5H X 2.5-3.5D*
- MEDIUM 8W X 4.5H X 2.5-3.5D*
- LARGE 10W X 4.5H X 2.5-3.5D*
- CUSTOM SPECIFY*

EE7V Flip Back Rock and Roll Headrest with Pad

Pad: 7756 Chubbie: This oval shaped pad has a 1/4" ABS base with 1" of 10# foam and an additional 1" of 3# foam on top. The foam is rolled over the edges of the base for skin protection. Zippers allow foam access.
Hardware: Rock and Roll: Multiple axial adjustments, height adjustable with track and flip down function.



(Face of pad measurements)

- SMALL 8W X 4.5H X 2.5D*
- MEDIUM 10W X 4.5H X 2.5D*
- LARGE 12W X 4.5H X 2.5D*
- X-LARGE 14W X 4.5H X 2.5D*
- CUSTOM SPECIFY*



HEAD SUPPORT MODIFICATIONS

Mod-7H Curved Extension Pad

This modification will take your flat headrest extension and curve it to match a curved back.



Mod-7J Occipital Ledge

Use this modification to add an occipital ledge to any headrest pad. Please provide placement and dimensions.



Mod-7K Re-Cover Headrest

Mod-7L Single Pad Replacement For EE7E



This section is divided into three groups:

*Upper Extremity Supports
Lower Extremity Supports
Trays*

UPPER EXTREMITY SUPPORTS

The Standard Arm Trough

Arm troughs are constructed of ABS with 1/2" of 3# foam and your choice of upholstery excluding nylon and cordura. Standard arm troughs have an inside and outside lip, elbow stop and wrist cock up proportional to the size of the trough. Custom arm troughs can be made to fit exact client size when dimensions of forearm, palm length and finger length are provided. Arm troughs can be ordered in a custom configuration, when a diagram is provided. All arm troughs come with 1" nylon webbing straps with faux sheepskin covers. Hook & loop straps are standard. Buckle closure is available upon request, at no additional charge.

Standard sizes are as follows:

<i>SMALL</i>	<i>Pediatric</i>
<i>MEDIUM</i>	<i>Adolescent</i>
<i>LARGE</i>	<i>Adult</i>
<i>X-LARGE</i>	<i>25" Circumference</i>



UPPER EXTREMITY SUPPORTS

09-2000 Arm Trough with T-Nuts

A standard arm trough with t-nuts at 1" increments. Please specify size. Nylon and cordura can not be used in arm troughs



09-3000 Arm Trough with Multi Axial Hardware

A standard arm trough with hardware that allows a full range of adjustments. Designed to be mounted to round tubing in 1", 7/8" or 3/4" clamps. Please specify tubing size when ordering. This hardware has a ball and socket mounting that allows anterior / posterior elevation, as well as lateral adjustment for supination and pronation of the forearm. Nylon and cordura can not be used in arm troughs.



09-5000 Forearm / Wrist Cuff

Nylon webbing and a pad of 5# foam make up these cuffs. Standard cuffs are sent with 1 1/2" webbing. Your choice of fabric is available. Please Indicate wrist circumference or forearm size. Standard cuffs sent with grommet attachment. Mounting plates are available upon request.





108-1000 Thigh Cuffs

High quality nylon webbing and a 5# foam pad make up these cuffs. Standard cuffs are sent with 2" webbing. Your choice of fabric is available. Standard sizes are based on client age/size. Please indicate thigh circumference when available. Standard cuffs are sent with grommet attachment. Mounting plates are available upon request.

Standard sizes are as follows:

SMALL	PEDIATRIC
MEDIUM	ADOLESCENT
LARGE	ADULT



108-4000 Calf Troughs

Our calf troughs are made with ABS. A 1/4" of 3# foam is applied and your choice of fabric, excluding nylon and cordura, is available. Calf troughs come with mounting clamps and brackets designed to mount to 1", 7/8" or 3/4" round tubing. The mounting brackets allow lateral adjustment to ensure proper positioning. Standard sizes available based on client age / size. Custom sizes are available at no additional charge when you provide a diagram.

Specify sizes:

Length	Width	Outside or Inside Dimensions
--------	-------	------------------------------



108-6000 Ankle Cuffs

High quality nylon webbing and a 5# foam pad make up these cuffs. Standard cuffs are sent with 1" webbing. Your choice of fabric is available. Standard sizes are based on client age/size. Please indicate ankle circumference when available. Standard cuffs are sent with grommet attachment. Mounting plates are available upon request.

Standard sizes are as follows:

SMALL	PEDIATRIC
MEDIUM	ADOLESCENT
LARGE	ADULT
SMALL	PEDIATRIC
MEDIUM	ADOLESCENT
LARGE	ADULT





108-7000 Calf Cuffs

High quality nylon webbing and a 5# foam pad make up these cuffs. Standard cuffs are sent with 2" webbing. Your choice of fabric is available. Standard sizes are based on client age / size. Please indicate calf circumference when available. Standard cuffs are sent with grommet attachment. Mounting plates are available upon request.

Standard sizes are as follows:

SMALL	PEDIATRIC
MEDIUM	ADOLESCENT
LARGE	ADULT



108-8000 Solid Foot Board

High quality birch plywood is waterproofed for long use. All solid foot boards come cut to fit between the hangers with mounting hardware. Please specify chair width and manufacturer's model. Depth of footboard must be provided.



EE8 Solid Calf Panel

A solid base of 1/2" marine grade plywood with 1" of 3# foam and your choice of fabric and color are standard on the calf panel. Width is based on the width of the chair it will be mounted to. All calf panels are cut to fit between the hangers, unless otherwise specified. Calf panel comes with 4 each 1" drop hooks and 30 degree clamps. Quick release hardware is available at a small up-charge. Please specify height of calf panel.



EE8A Fabric Calf Panel

This fabric panel is constructed in two styles. You may order it with a center pad of 1" 3# foam and your choice of fabric and color with webbing and hook & loop mounting that wraps around the hangers. The panel may also be made entirely of fabric with hook & loop closure that wraps around the hangers. Pad size is based on chair width. Please specify chair width & provide height of sling.



EE8B Calf Strap

The strap is made entirely of 2" webbing. Strap attaches with hook & loop closure that wraps around the hangers. Please specify the chair width.





08-10000 Single Leg Cradles

Leg cradles have a double ABS construction. A layer of 1/2" 3# foam is secured to the inside panels. Your choice of fabric is available, excluding nylon and cordura. There are no standard sizes available for leg cradles. Width is based on chair width and cradles are cut to fit between the hangers. Please specify height and depth of cradles. Mounting hardware is included. Please indicate hanger mount, foot plate mount or mounting under solid seat with L-brackets.



08-11000 Bilateral Leg Box

Bilateral leg box has a double ABS construction. A layer of 1/2" 3# foam is secured to the inside panels. Your choice of fabric is available, excluding nylon and cordura. There are no standard sizes available for bilateral leg boxes. Width of box is based on chair with and the box is cut to fit between the hangers. Please specify height and depth of box. Mounting hardware is included. Please indicate hanger mount, footplate/board mount or mounting under solid seat with L-brackets.

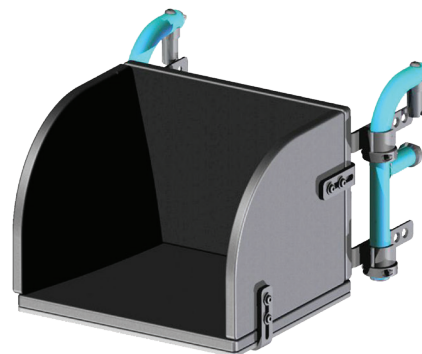

EE9 Shoe Holder with Hook & Loop Closure

Freedom Designs, Inc. shoe holders are form molded into square shape in six sizes to fit your positioning needs. (No custom sizes are available). Single D-ring closure with hook & loop is adjustable. The ankle strap has a movable pad in your choice of fabric and color. It will come in F-03 if not specified. Standard toe strap is not padded. Toe strap padding is available upon request at no up-charge. See Shoe Holder Chart for sizes

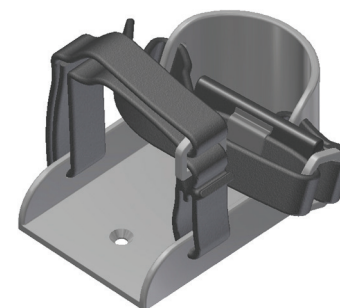



EE9B High Tops—Static

Designed to provide ankle support as well as foot positioning. The sturdy padded soft supports are constructed of cordura and 1" nylon webbing. Extra strength is assured by leather reinforcement. Standard High-Tops have a hook & loop, single D-ring closure. A cam or squeeze release buckle closure is available at no additional charge.

Standard sizing is based on ankle circumference as follows:

- X-SMALL 1" WEBBING 5 1/2" TO 8 1/2"
ANKLE CIRCUMFERENCE
- SMALL 1" WEBBING 7 1/2" TO 10 1/2"
ANKLE CIRCUMFERENCE
- MEDIUM 2" WEBBING 9 1/2" TO 12 1/2"
ANKLE CIRCUMFERENCE
- LARGE 2" WEBBING 11 1/2" TO 14 1/2"
ANKLE CIRCUMFERENCE



EE9B-D High Tops—Dynamic

Same as EE9B but constructed of high quality neoprene stretch material.

EE9C Shoe Holder with Buckles

Freedom Designs, Inc. shoe holders are form molded into a square shape in six sizes to fit your positioning needs. (No custom sizes are available). The ankle and toe straps have a movable pad. The shoe holder design allows for easy in field replacement of straps. Pads are available in your choice of fabric and color, they will come standard in F-03 if not specified. See Shoe Holder Chart for sizes.



EE9D Heel Loop

High quality 2" nylon webbing makes up this heel loop. Sizes are based on client age/size as follows:

- SMALL PEDIATRIC
- MEDIUM ADOLESCENT
- LARGE ADULT





EE9E Heel Loop with Ankle Strap

High density 2" nylon webbing makes up the heel loop, while 1" webbing with a cam buckle closure completes the ankle strap. Available in three sizes based on client age/size as follows:

SMALL	PEDIATRIC
MEDIUM	ADOLESCENT
LARGE	ADULT



EE9F 3 Point High Tops—Static

Designed to provide ankle support as well as foot positioning. The sturdy 3 pronged padded soft supports are constructed of cordura and 1" nylon webbing. Extra Strength is assured by leather reinforcement. Standard High-Tops have a hook & loop, single D-ring closure. A cam or squeeze release buckle closure is available at no additional charge.

Standard sizing is based on ankle circumference as follows:

X-SMALL	1" WEBBING 5 1/2" TO 8 1/2" ANKLE CIRCUMFERENCE
SMALL	1" WEBBING 7 1/2" TO 10 1/2" ANKLE CIRCUMFERENCE
MEDIUM	2" WEBBING 9 1/2" TO 12 1/2" ANKLE CIRCUMFERENCE
LARGE	2" WEBBING 11 1/2" TO 14 1/2" ANKLE CIRCUMFERENCE

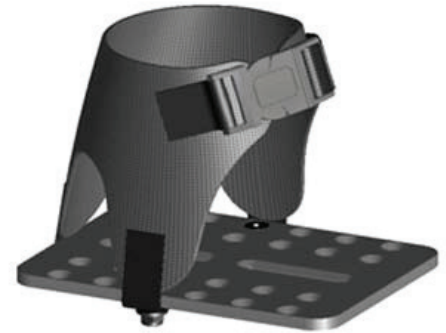

EE9F-D 3 Point High Tops—Dynamic

Same as EE9B but constructed of high quality neoprene stretch material.

EXTREMITY SUPPORT MODIFICATIONS

Mod-9A Recover Armrest Pads

This modification can be used to order upholstery for existing pads or when returning pads to our factory for recover. (Must have a valid Return Authorization #). When ordering pad covers only, please provide all dimensions or original order information. Covers sent will require staple closure.



Mod-9B Ankle Straps with Pads

Straps are designed to mount to existing shoe holders or may be mounted as independently mounted ankle straps. Straps are constructed of 1" hook & loop and a single D-ring closure. Buckles are available with 1" nylon webbing at no additional charge, upon request. Standard sizing is based on shoe holder sizes. Custom straps and pads are available when you provide a diagram. Straps ordered without buckles are not field replaceable.

Specify small, medium or large.



Mod-9C Ankle Strap Pads Only

Replacement pads for 1" wide shoe holder straps are available with this modification. Sizes of straps are based on shoe holder sizes. Your choice of fabric and color are available.

Specify length or small, medium or large.

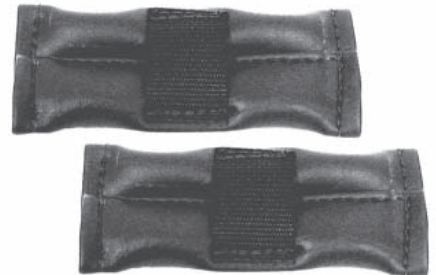

Mod-9D Toe Strap-No Pads

Straps are made of 1" hook & loop with a single D-ring closure. Designed to mount to existing shoe holders, these straps may also be mounted independently to the foot plate. Straps ordered without buckles are not field replaceable.

Specify small, medium or large.



Mod-9E Pad Inside of EE9 Shoe Holder

This modification will provide a padded contact surface on the inside of the shoe holder. Padding will decrease available width and depth inside measurements. Padding is glued to the inside and finished with plastic edge guard. Available in your choice of fabric and color. This charge is added to the price of the shoe holder.



Mod-9F Armrest Pads Only

Replacement pads for existing hardware are available with this modification. Please provide width and length dimensions. Pads come t-nutted for Freedom Designs, Inc. hardware. Other t-nut patterns are available upon request for an up-charge.

Specify length x width, color & upholstery

(See Mod-1Q for charges)



Mod-9G Footboard or Footplate Pads

A single pad made for footboard or 2 pads made for footplates. Made of 1" 4# foam with velcro on the bottom to attach. Please specify size and upholstery color.



Mod-9GW Footboard Pads with Wood Base

Mod-9GW is the same as Mod-9G except the base is constructed of marine grade plywood & 1" 4# foam. We T-nut at 1" spacing to attach to footplates. Please specify size and upholstery color.





The Standard Tray

Freedom Designs, Inc offers two materials for tray surfaces. Lexan is available as well as birch (wood). All hardware is available on both tray surfaces, although hardware mounting techniques vary. Hardware restrictions apply to several styles of birch trays and will be explained under the model number description. Tray sizing is based on chair width and in some instances, outside armrest width. See model number description for armrest notations. Custom sizes are available upon request. Joystick cut outs are available at no charge when you provide a diagram. Lexan trays are 3/8" thick (1/4" thick for EZ-Lite trays) and the birch tray is 1/2" thick.

Standard sizes are as follows:

<i>X-SMALL</i>	<i>10" - 11" WIDE CHAIR, 21" WIDE X 18" DEEP BODY CUT OUT 10" WIDE X 7" DEEP</i>
<i>SMALL</i>	<i>12" - 13" WIDE CHAIR, 21" WIDE X 18" DEEP BODY CUT OUT 12" WIDE X 7" DEEP</i>
<i>MEDIUM</i>	<i>14" - 15" WIDE CHAIR, 24" WIDE X 22" DEEP BODY CUT OUT 14" WIDE X 9" DEEP</i>
<i>LARGE</i>	<i>16" - 17" WIDE CHAIR, 26" WIDE X 24" DEEP BODY CUT OUT 16" WIDE X 10" DEEP</i>
<i>X-LARGE</i>	<i>18" - 19" WIDE CHAIR, 28" WIDE X 24" DEEP BODY CUT OUT 18" WIDE X 10" DEEP</i>

LARGER TRAY SIZES ARE AVAILABLE UPON REQUEST AT NO ADDITIONAL CHARGE.



08-1000 Lexan Tray with Hook & Loop Mounting

This tray offers a mounting that is hook & loop and secures around the armrest. Closure is sent to fit most standard armrests. If longer hook & loop is required, please specify overall length required.

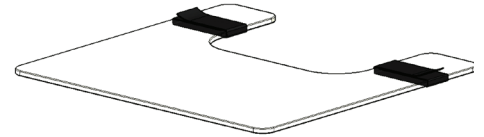

08-2000 Lexan Tray with Channel Brackets & Ribs

The hardware allows easy slide on/off mounting. Aluminum channel brackets slip over both tubular and desk style arms. Minimum width adjustment in the hardware requires chair width and armrest style to ensure proper fit. Hardware can be sent not mounted and the tray not drilled, to allow correct hardware placement in the field.

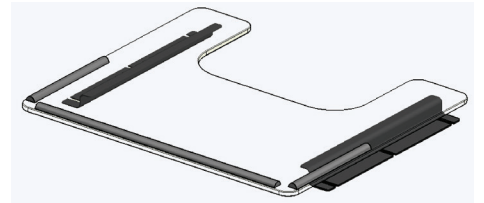

08-2500 Birch Tray with Channel Brackets

The hardware allows for easy slide on/off mounting. Aluminum channel brackets slip over both tubular and desk arm styles. Minimum width adjustment in the hardware requires the chair width and armrest style to ensure proper fit. Hardware can be sent not mounted and the tray not drilled, to allow correct hardware placement in the field.





08-4000 Birch Tray with Hook & Loop Mounting

This tray offers hook and loop mounting that secures around the armrest. Closure is sent to fit most standard armrests. If longer hook & loop is needed, please specify overall length required



08-6000 Lexan Tray with Adjustable Knob Release & Ribs

The hardware enables a secure lock down of the tray. Large star knobs facilitate quick and easy transfers. The tray is slotted, allowing for ample width adjustment to ensure proper fit. Slotted mounting requires 5" of lexan be present on both sides of the body cut out, to avoid stress fractures and breakage. This model comes with aluminum ribs on the leading edges and front 2/3 of the sides of the tray.

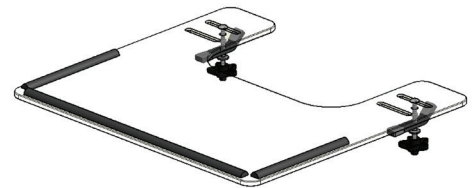

08-6500 Birch Tray with Adjustable Knob Release

The hardware enables a secure lock down of the tray. Large star knobs facilitate quick and easy transfers. The tray is slotted, allowing for ample width adjustment to ensure proper fit. Slotted mounting requires 5" of birch be present on both sides of the body cut out, to avoid stress fractures and breakage.



08-7000 Lexan Tray with Toggle Clamp Release

This hardware is designed to provide a positive lock on both tubular and desk style armrests. Easy to operate, single motion lever snaps into locked position. The tray is slotted, allowing for ample width adjustment to ensure proper fit. Slotted mounting requires 5" of lexan be present on both sides of the body cut out, to avoid stress fractures and breakage.

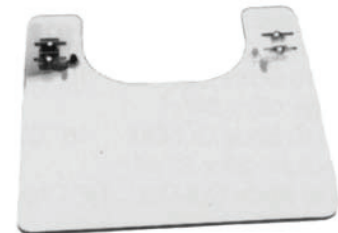

08-7500 Birch Tray with Toggle Clamp Release

This hardware is designed to provide a positive lock on both tubular and desk style armrests. Easy to operate, single motion lever snaps into locked position. The tray is slotted, allowing for ample width adjustment to ensure proper fit. Slotted mounting requires 5" of birch be present on both sides of the body cut out, to avoid stress fractures and breakage. Tray ribs do not come standard on this tray but may be ordered—see Mod-8N.





08-8000 Lexan Tray without Hardware

This tray blank allows you to mount your own hardware or use existing hardware.

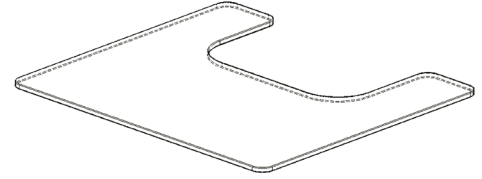

08-8500 Birch Tray without Hardware

This tray blank allows you to mount your own hardware or use existing hardware.



08-9000 Quick Release, Height Adjustable Half Tray

This half tray comes in lexan or birch. The hardware is height adjustable, as well as quick release. Hardware must be mounted to a lateral hip/thigh support. Please specify size and side to be mounted on. Easel is a modification to the tray—Mod-8R. All modifications may be ordered on this half tray, please specify.

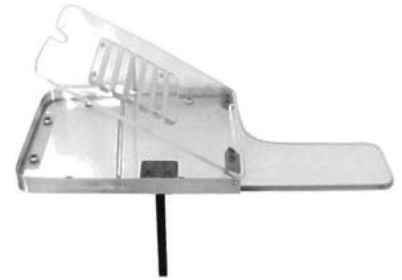

08-12000 EZ-Lite Lexan Tray

This lightweight tray is made up of 1/4" thick lexan with aluminum channels designed to fit on either padded or foam grip style armrests.

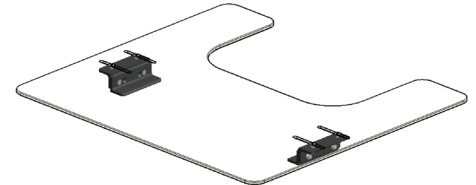

08-13000 EZ-Lite Lexan Tray with Ribs

This is the standard 08-12000 EZ-Lite Tray with aluminum ribs on the leading edges and front 2/3 of the sides of the tray.

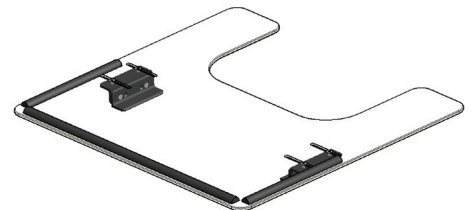

08-14000 Tray—Spring Loaded Release for Padded Armrests

Quick release lexan tray. Uses pull type release slides to attach to the wheelchair.

08-14000R Same as above with Ribs





08-15000 Tray with Locking Hooks for Use With 1" Diameter Armrest Tubes

This is a quick release lexan tray with locking hooks to secure the tray to the wheelchair arms. This tray is for use with wheelchairs equipped with 1" diameter armrest tubes.



18-15000R Same as above with Ribs

08-16000 Tray—1/4" Thick Lexan with Hook & Loop Mount

This is a 1/4" thick lexan tray with hook & loop mounting that secures around the armrest. Closure is sent to fit most standard armrests. If longer hook & loop is required, please specify overall length required.



08-17000 Lexan Tray—1/4" Thick—No Hardware

This tray is 1/4" thick lexan with no mounting hardware.

Mod-8B ABS Surface Overlay

A layer of black ABS is applied to the top of the lexan tray. The ABS is not removable.



Mod-8G Aluminum Rim

A one piece aluminum rim of 90 degree angle is mounted under the tray to the anterior and lateral edges. 1/2" of the rim is above the tray surface. The rim prevents items from rolling off of the tray, while also protecting the tray edges from damage.



Mod-8H Plastic Rim Guard

Metal reinforced plastic can be mounted to the tray edges for protection from impact. Plastic rim may also be mounted to the aluminum rim to provide client protection from aluminum edges. May be purchased off the tray when you provide tray dimensions.



Mod-8J Rear Stability Belt

The belt is designed to mount to the tray, providing additional security to prevent client removal. 1" webbing straps with a squeeze release plastic buckle enables easy transfer. Strap length is based on chair width.





Mod-8K Elbow Blocks

Constructed of 1/2" marine grade plywood and 1/2" of 3# foam. Pads mount to the tray with dual slotted L-brackets. Standard size is 5" long x 4" high. Custom sizes are available at no additional charge. Please provide Length x Height dimensions.



Mod-8L Pad Tray Top Only

Padding attaches with hook & loop to the bottom surface of the tray. 1/2" of 4# foam with your choice of fabric and color are available. Naugahyde is recommended for long wear and ease of cleaning.



Mod-8L1 Pad Tray Top & Bottom

Padding attaches to the tray with hook & loop. Entire tray top is padded and the bottom of the tray is padded to the body cut out. Your choice of fabric and color is available. Naugahyde is recommended for long wear and ease of cleaning.



Mod-8M Pad Half Tray

This modification pads the rear of the tray to the body cut out. This modification may also be used to pad the anterior portion of the tray. The tray pad attaches to the tray top and bottom with hook & loop.



Mod-8N Tray Ribbs—Wood, Lexan, Aluminum

Tray ribs can be mounted to any tray surface. Ribs are half round material for a smooth, edge free, contact area. Available in wood, lexan or aluminum. If no preference is specified, aluminum will be sent. Available for purchase off the tray, please specify tray size or length of ribs needed. Three ribs make up this modification.

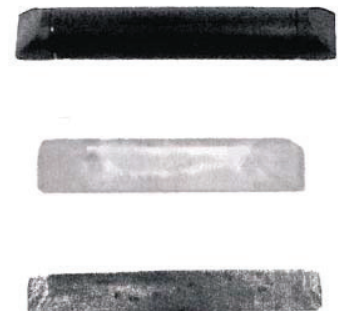



Mod-8O Elbow Pads with Hook & Loop Mounting

The pads are mounted to the tray surface with hook & loop. A 1" layer of 3# foam and your choice of fabric and color are available. Opposing hook & loop sent to attach to tray. Please specify size. Standard sizes are available based on tray size.



Mod-8P Overlay

A thin layer of lexan is elevated above the tray surface. This non-removable overlay is perfect for educational and communication applications. Size of overlay is proportional to size of the tray. The tray base is sold separately.

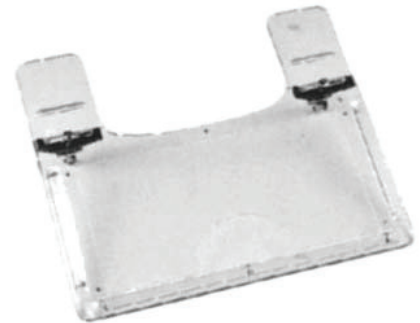

Mod-8Q Underlay

A thin layer of lexan is dropped slightly below the trays bottom surface. This location is not client accessible. This non-removable underlay is perfect for educational and communication applications. Size of underlay is proportional to size of tray.



Mod-8R Removable Easel

The hardware is designed to give you a multi angle, adjustable elevating surface. When not needed, it can be removed, providing a usable tray surface for feeding or other learning skills. Easel size is proportional to the size of the tray. Tray and base are sold separately.



Mod-8S Tray Trim

Black plastic trim of 90 degree angle is mounted around the tray to the anterior and lateral edges. The trim protects the tray edges from damage by impact. Black trim may also be mounted to the aluminum rim to provide client protection from aluminum edges.





11-1000 Vent Tray

The vent tray is constructed of a phenolic base with an aluminum to prevent equipment from sliding off of the tray. A solid cover of loop is secured to the phenolic surface for added equipment safety. Tray is t-nutted for multiple adjustment possibilities. Tray width is based on chair width. The trays are cut to fit between the frame rails. It is mounted to the lower frame rails with 1" drop hooks and 30 degree clamps. Depth of the vent tray is proportional to the chair width. Custom sizes are available upon request. If the batteries do not fit on the vent tray, a second vent tray needs to be ordered, please specify size.



11-1000C Vent Tray with Hinged Quick Release

The vent tray is constructed of a phenolic base with aluminum rim to prevent equipment from sliding off the tray. A solid cover of loop is secured to the phenolic surface for added equipment safety. Tray is t-nutted for multi adjustment possibilities. Tray width is based on chair width. Trays are cut to fit between the frame rails. Tray mounts with J-hook, hinged L-bracket and quick release frame clamps. Clamps to the lower frame rails. Depth of vent tray is proportional to chair width. Custom sizes are available upon request.



11-2000 O2 Tank Holder—Upholstered

The tank holder is designed to hold a variety of O2 and liquid oxygen tanks. Please indicate tank size re: C-tank, E-tank or manufacturers name and model of liquid O2 tank. When possible, please provide a template for the liquid oxygen tank. The template will help to ensure proper fit of the various styles of liquid O2 tanks. Designed to mount to a solid back or the back post of the chair. The top of the tank is secured with a webbing strap, while the bottom rests in an upholstered receiver.

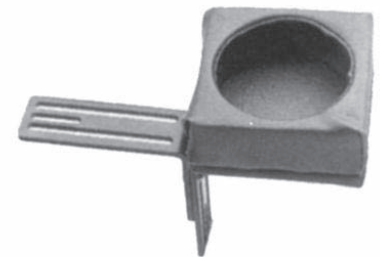



11-3000 O2 Tank Holder—Aluminum

This tank holder is designed to fit most standard round O2 tanks. (Will not work on Liquid O2 tanks). The tank holder is a sturdy one piece aluminum construction mounts to a solid back. Star knobs tighten down to hold the tank securely in place. This tank holder comes in one size only.

11-3000A O2 Tank Holder, Aluminum—No Hardware

The 11-3000 O2 Tank Holder shown above without hardware.

Mod-11A O2 Tank Holder Strap (only offered with 11-3000 and 11-3000A)

This is an oval ring with webbing flanges and fastex buckles. The oval ring goes over the vertical post of an O2 tank and the webbing ends with a male fastex buckle. The tank holder has the female side of the buckle and webbing attached to the tank holder. Once the fastex buckles are connected and the webbing is pulled tight, the O2 tank is secure from vertical movement during transport.



11-4000 I.V. Pole—Quick Release

The hardware is designed to clamp to the 1", 7/8" or 3/4" round back post. Large star knob allows quick vertical adjustment as well as easy quick release.



11-5000 Battery Tray

This is an aluminum tray with non-removable attachment hardware that is a support surface for ventilator accessories.

11-6000 Battery Tray Quick Release

This is an aluminum tray with removable attachment hardware that is a support surface for ventilator accessories.





FBP Freedom Back Pack

Freedom Designs, Inc. offers our backpack in any fabric we carry. For the longest wear, we recommend cordura or naugahyde.

FHP Freedom Hip Pouch

Hip pouches are available in any fabric and color we carry. For longest wear, we recommend cordura or naugahyde. A free monogram is available when the backpack is ordered with a seating system (solid seat & back with hardware). See Mod-2T for charges when no seating system is ordered.

FMNP Freedom Medical Necessities Pouch

Designed to mount to the frame of the chair for user access. Grommet ends bolt to the frame. May have hook & loop attachment when requested, at no additional charge.

FCA Freedom Calipers

Just the tool needed to measure chest width, head width, hip width, etc. The light weight wood design makes this a perfect tool for the tool bag on the go.

FABRIC AND YARD GOODS

FHL Hook & Loop

Hook & loop is available in several widths and styles. 1", 1 1/2" and 2" strips are available in self-stick and sew on strap use. Please specify width of hook & loop and mounting style. Modification is for both sides (hook & loop)

FWEB Nylon Webbing

High quality nylon webbing is available by the yard. Please specify webbing width of 1/2", 3/4", 1", 1 1/2" or 2".

UPH-LN Lycra/Neoprene Fabric

Please specify by fabric number/color needed. Fabric is approximately 45" in width.

UPH-NA Naugahyde/Cordura/Nylon—Sailcloth Fabric

Please specify by fabric number/color needed. Fabric is approximately 60" in width.

UPH-DAR Darlex/Dartex/Darflex

Please specify fabric type needed. Fabric is approximately 58" wide.



FABRIC AND YARD GOODS

FHL Hook & Loop

Hook & loop is available in several widths and styles. 1", 1 1/2" and 2" strips are available in self-stick and sew on strap use. Please specify width of hook & loop and mounting style. Modification is for both sides (hook & loop)

FWEB Nylon Webbing

High quality nylon webbing is available by the yard. Please specify webbing width of 1/2", 3/4", 1", 1 1/2" or 2".

UPH-LN Lycra/Neoprene Fabric

Please specify by fabric number/color needed. Fabric is approximately 45" in width.

UPH-NA Naugahyde/Cordura/Nylon—Sailcloth Fabric

Please specify by fabric number/color needed. Fabric is approximately 60" in width.

UPH-DAR Darlex/Dartex/~~Darflex~~

Please specify fabric type needed. Fabric is approximately 58" wide.



Cushions

Freedom Designs, Inc. uses only the best quality foams. All foams are fire retardant and meet flammability standards of the Federal and State Consumer Affairs Agencies. Foam is available in large pieces (call Customer Service for a quote). Cushions come in standard sizes, however custom cushions are available. Custom cushion pricing is based on the size of the cushion. All cushions come with a polyester double knit cover, in your choice of black, brown or navy. Other cover fabric is available (see Mod-10E for up-charge).

Standard Cushion sizing is as follows:

*16" WIDE X 16" DEEP X 2" THICK
16" WIDE X 16" DEEP X 3" THICK
16" WIDE X 16" DEEP X 4" THICK*

*18" WIDE X 16" DEEP X 2" THICK
18" WIDE X 16" DEEP X 3" THICK
18" WIDE X 16" DEEP X 4" THICK*

Density:

Density refers to the weight per cubic foot. For Instance: A cubic foot of 3# foam weighs 3 pounds.

I.L.D.:

Indention Load Density shows how supportive the foam will function at different degrees of compression. The higher the I.L.D. rating, the more support it will provide.

H.R. Foams:

High resiliency foams are open cell, polyurethane foams. They retain their characteristics for a longer period of time. H.R. foams are available in 3#, 4# and 5# densities.

- *X-soft—Soft—Med—Firm*
- *Ideal for top layer*
- *Extra soft good on back with 4# or 5# foam*
- *Better for small children*



Single Foam & Multi Laminates

The Velfloat:

For light flotation and comfort, 40-50 I.L.D. 3# density (medium density). Velfloat allows maximum penetration and conformity. This is good as a comfort cushion or top layer of a laminated cushion.

The High Density:

70 I.L.D. for medium flotation and good stability. 4# density (high density). This density foam also has enough integrity to hold a cut out well. 4# foam is good for a top layer, with a cut out or as a base layer for a softer foam.

The Tufloat:

90 I.L.D. for medium to high flotation and excellent stability. 5# density (x-high density). 5# foam is good for a bottom layer in laminations and good for a top layer with a cut out.

The Pudgee:

A solid, gel like foam for the ultimate in penetrability and conformation. Pudgee has an open-celled structure, visco-elastic gel foam with a unique dough like consistency. This foam will mold to the body, provide maximum conformity with minimum tension.

- *Conforms slowly*
- *Least skin shear*
- *Firm, yet you get compression*

The Sunmate:

A high-density 100% open cell foam of 5 lbs per cubic foot density. Foam provides high impact absorption properties. Contours slowly to give uniform pressure distribution and soft spring back. Available in SOFT, MEDIUM & FIRM

- *Slow Contouring*
- *100% Shock Absorption*
- *Excellent Distribution*



Single Foam & Multi Laminates

The T-Foam:

A temperature sensitive foam that conforms to the body.

T-foam is a high density 100% open cell polyurethane foam and has high impact absorption properties. Temper Foam is available in X-Soft, Soft, Medium and Firm densities. This foam offers up to 97% impact absorption without bottoming out and conformation, to uniformly distribute pressure, yet provides firm support. This foam makes an ideal top layer in a lamination with a 4# or 5# cushion as a base.

The Dyna-Flo T:

Laminations of Soft, Medium and Firm T-Foam. Dyna-Flo T offers conformity, impact absorption and a slow rate of return from deflection.

The Bi-Float:

The bottom half is Duraloat II and the top half is Velfoat for comfort, penetration and high flotation. This cushion can be rebuilt for ultra long life. 10# base with a 3# top.

The Hi-D Laminate:

The top inch is High Density foam while the base is Tufloat for excellent flotation and stability. 5# base with a 4# top.

The Formfloat II:

The top layer of Dyna-Flow with progressive lamination of High Density and Tufloat provides the ultimate in penetration, comfort and stability. Pressure readings are consistently comparable to the Jay and Roho cushions. 5# base, 4# center and Flow Foam top

Free Float:

A solid Gel for the ultimate in penetrability and conformation. Free Float has a closed cell structure with a visco-elastic gel consistency. This foam can be punctured, however it is self gravitating to heal itself, never ending up with any leakage. Great as a top layer for pressure relief. Should be used in combination with a dense base foam. Comes in 1/2" thickness only and a maximum size of 18" x 16". A stretch cover is suggested.

Waffle Free Float:

A solid gel with 1" x 1" blocks on the surface for the ultimate in penetration and conformation. Waffle Free Float has a closed structure with a visco-elastic gel consistency. This foam can be punctured, however it is self gravitating to heal itself, never ending up with any leakage. This waffle surface breaks up the resistance for patient comfort. Great as a top layer for pressure relief. Should be used in combination with a dense base foam. Comes in 1./2" thickness only and a maximum size of 18" x 16". A stretch cover is suggested.



Single Foam & Multi Laminates

Mod-10A

Special Size Cushion with custom width, depth and/or thickness

Mod-10E

Custom Cushion cover made of naugahyde, sailcloth, lycra, neoprene, darlex or cordura. Knit covers are standard.

Mod-10I

*Ischial Cut-Out
7" wide x 6" deep*

Mod-10J

*Coccygeal Cut-Outs
3" wide x 4" deep*

Mod-10K

*Wedge Cut
A wedge cut either front to rear or left to right: please specify*

Mod-10M

*Pre-Ischial Bar
3" deep x 2" thick*

Mod-10N

Tie

Mod-10O

Tabs with Snaps

Mod-10P

Sealed Incontinent Liner

Mod-10Q

Non-Skid Base

Mod-10R

Hook & Loop

Mod-10S

Anti Thrust

Mod-10T

Contour, Abductor, Anti Thrust

Mod-10U

Contour, Adductor, Anti Thrust

Mod-10V

Contour, Abductor, Adductor, Anti Thrust

Mod-10W

Grid Style Cover

Mod-10X

Applewood Cushion Base



Freedom Designs, Inc. offers a variety of upholsteries to use on our systems. We are constantly adding new materials as they come available. Please consult your color chart for the colors that the following colors come in! If you do not have a color swatch, call our Customer Service Department and one will be sent out. Colors may be discontinued by the manufacturer at any time.

NO latex is present in any Freedom Designs, Inc. fabric.

Naugahyde

A vinyl-coated, waterproof and durable fabric.

Comes in a multitude of colors.

Care: Mild soap and water or gentle solvents.

Nylon/Sailcloth

Also known as para-pak. A smooth, silky nylon material.

Care: Mild soap and water.

Lycra/Neoprene

Similar to double-knit material; however, it has a laminated rubber backing—similar to wetsuit material.

Care: Mild soap and water.

Shelterlite

A vinyl-coated fabric, waterproof and durable—similar to naugahyde except that it has a ridge texture.

Cordura

A woven-like nylon material with breathability.

Comes in a variety of colors.

Care: Mild soap and water.

Darlex/Dartex/~~Darflex~~

A four way stretch fabric that is water resistant and breathable.

Care: Mild soap and water.



NAUGAHYDE F & K SERIES

Number	Name	Number	Name
F-01	ACORN	F-61	DARK BLUE SHELTERLITE
F-03	BLACK	F-62	BLACK SHELTERLITE
F-04	DARK BLUE	F-64	GRAPE PEBBLE No Longer Available
F-05	DARK RED	F-65	MIDNIGHT BLUE PEBBLE No Longer Available
F-06	OFF WHITE	F-66	BLACK DARLEX
K-06	PLUM	F-68	CAMEO No Longer Available
F-07	BUCKSKIN	F-69	TYRIAN PLUM No Longer Available
F-09	ROYAL BLUE	F-70	AGATE No Longer Available
K-09	BRIGHT YELLOW	F-71	JADESTONE No Longer Available
F-10	SKY BLUE	F-73	CROCUS
K-10	BRIGHT GREEN	F-75	SPACE BLUE
F-12	LIGHT BLUE SHELTERLITE	F-76	GRAY MIST No Longer Available
K-13	RASPBERRY	F-80	MARINE
F-14	MOCHA	F-81	ORCHID
K-14	SPARKLE BLUE	F-82	CHARCOAL PEBBLE No Longer Available
F-15	NAVY BLUE	F-83	HAZE No Longer Available
K-15	SPARKLE BLACK	F-84	CRANBERRY No Longer Available
F-16	NUTMEG	F-85	MACAW
K-16	SPARKLE RED	F-87	ASH No Longer Available
K-17	SPARKLE PURPLE	F-88	RADIANT DUSK No Longer Available
F-18	PIMENTO (K11) No Longer Available	F-92	DARK BLUE (NAVY)
F-19	EARTHSTONE	F-93	SLATE No Longer Available
F-21	FOREST GREEN	F-94	NAVY
F-24	EMERALD GREEN	F-95	DARK BURGUNDY No Longer Available
F-25	BURGUNDY	F-96	CARBON
F-26	DUSTY ROSE	F-98	CLARET No Longer Available
F-27	BLACK	F-99	OCEANA No Longer Available
F-28	BRIGHT RED	F-101	FESTIVAL No Longer Available
F-29	PLATINUM	F-102	SAND GRAPE No Longer Available
F-32	PEACH	F-105	LAUREL GREEN
F-35	LAVENDER No Longer Available	F-106	RED RUBY
F-36	PURPLE	F-107	LUXOR BLUE
F-37	ICE PINK No Longer Available	F-108	BLUEGRASS No Longer Available
F-38	TURQUOISE	F-109	ORANGE KIST
F-42	SOFT GRAY	F-110	PURPLE NAVY No Longer Available
F-51	SEA FOAM SPLASH		



CORDURA
C SERIES

Number	Name	Number	Name
C-07	ROYAL BLUE	C-17	DARK BLUE
C-16	BLACK	C-21	BURGUNDY

NYLON/SAILCLOTH
N SERIES

Number	Name	Number	Name
N-05	BLACK	N-20	NAVY BLUE
N-11	ROYAL BLUE		

LYCRA/NEOPRENE
L SERIES

Number	Name	Number	Name
L-05	BLACK	L-18	BRIGHT PURPLE
L-06	SILVER	L-19	BURGUNDY
L-13	ROYAL BLUE	L-20	DARK BLUE
L-14	BRIGHT RED	L-23	FOREST GREEN
L-15	TURQUOISE		

DARLEX/DARTEX/DARFLEX
D SERIES

Number	Name	Number	Name
DL-1	DARLEX BLACK	DT-2R	DARTEX BLACK—REVERSE
DF-3	No Longer Available DARFLEX BLACK	DT-3	No Longer Available DARTEX BALLONS
DT-2	DARTEX BLACK		



403A
B
C



403AM
BM
CM



404A
B



405A1B



405A1



405S1



406A1



406S1



407A1



407S1



408



410



411



413A



413S



414A



414S



415A



415S



416

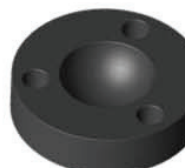

418



PART No.	DESCRIPTION	SIZE
403A	SPLIT COLLAR CLAMP—1" with PIN	N/A
403AM	SPLIT COLLAR CLAMP—MILLED 1" with PIN	N/A
403B	SPLIT COLLAR CLAMP—7/8" with PIN	N/A
403BM	SPLIT COLLAR CLAMP—MILLED 7/8" with PIN	N/A
403C	SPLIT COLLAR CLAMP—3/4" with PIN	N/A
403CM	SPLIT COLLAR CLAMP—MILLED 3/4" with PIN	N/A
404A	LIT COLLAR CLAMP—1"	N/A
404B	SPLIT COLLAR CLAMP—7/8"	N/A
405A1B	0" DROP HOOK—ALUMINUM	2.75" w / 1.75" SLOT
405A1	1" DROP HOOK—ALUMINUM	2.75" W / 2" SLOT
405S1A	1" DROP HOOK—STAINLESS	2.75" W / 2" SLOT
406A1	2" DROP HOOK—ALUMINUM	2.75" W / 2" SLOT
406S1	2" DROP HOOK—STAINLESS	2.75" W / 2" SLOT
407A1	3" DROP HOOK—ALUMINUM	2.75" W / 2" SLOT
407S1	3" DROP HOOK—STAINLESS	2.75" W / 2" SLOT
408	U CLAMP—ONE SIZE	N/A
410	WASHER CLAMP—MILLED	N/A
411	WASHER CLAMP	N/A
413A	L-BRACKET—ALUMINUM	4" L / .75" SPACING
413S	L-BRACKET—STAINLESS	4" L / .75" SPACING
414A	J-BRACKET—ALUMINUM	4" L / .75" SPACING
414S	J-BRACKET—STAINLESS	4" L / .75" SPACING
415A	J & L W/FASTENERS—ALUMINUM	4" L / .75" SPACING
415S	J & L W/FASTENERS—STAINLESS	4" L / .75" SPACING
416	BALL BASE—MILLED	N/A
418	BALL BASE	N/A



424-2



428

430
PAIR



430A
PAIR



430B



430C



431



432A



432B



436



432C



432D



No Longer Available

436A



PART No.	DESCRIPTION	SIZE
424-2	ABDUCTOR BRACKET—FLIP	.75" SPACE SEAT/ 1" PAD
428	TRUNK SUPPORT ROD	N/A
430	SEAT TO BACK HINGE—OFFSET	5" LONG SLOT / BOTH
430A	SEAT TO BACK HINGE—FLUSH	4" SLOT BOTTOM / 6" TOP
430B	FLIP & FOLD SEAT TO BACK HINGE—STANDARD SIZE	
430C	FLIP & FOLD SEAT TO BACK HINGE—CHILD SIZE	
431	VERTICALLY REMOVABLE BRACKET	6.75 VERT. SLOT / 3.25" TOP
432A	FREE SWING THORACIC SUPPORT—SHORT	3" SLOT REAR / 2" FRONT
432B	FREE SWING THORACIC SUPPORT—LONG	3" SLOT REAR / 2" FRONT
(front plate longer)	1" DROP HOOK—ALUMINUM	2.75" W / 2" SLOT
432C	FREE SWING THORACIC SUPPORT—1" O/S	3" SLOT REAR / 1.5" FRONT
432D	FREE SWING THORACIC SUPPORT—2" O/S	3" SLOT REAR / 1.5 FRONT
436	30° CLAMP	3.5" LONG / 2" SLOT
436A	30° CLAMP—EE LITE	3.5" LONG / 2" SLOT



437A



437B



437C



437E



No Longer Available

437F



No Longer Available

437G



438



439



439A



No Longer Available

439B



442



442A



No Longer Available

442B



442C



443



443B



443C



PART No.	DESCRIPTION	SIZE
437A	BACK MOUNT BRACKET / EE2—2 SLOTS	2.5" SLOT
437B	BACK MOUNT BRACKET / EE2 HINGED	2.5" SLOT
437C	BACK MOUNT BRACKET—EE2 PEDIATRIC	1 1/8" SLOTS
437E	BACK MOUNT BRACKET—EE2— MICRO	1 1/8" SLOTS
437F	BACK MOUNT BRACKET—EE2 LITE	2.5" SLOT
437G	BACK MOUNT BRACKET—EE2 MICRO LITE	1 1/8" SLOTS
438	ABDUCTOR SLIDE BRACKET	4.5" SLOT OPEN / 3" CLOSED
439	SEAT MOUNT BRACKET —EE1	2.5" SLOT
439A	SEAT MOUNT BRACKET— EE1 MICRO	1 1/8" SLOT
439B	SEAT MOUNT BRACKET—EE1 LITE	1 1/8" SLOT
442	1" OFFSET FIXED THORACIC / HIP	3" SLOT / 1.5" SLOT FOR PAD
442A	1" OFFSET FIXED EXTENDED THORACIC / HIP	AS ABOVE / 3.25" BEFORE O/S
442B	1" REVERSE O/S FIXED THORACIC HIP	3" SLOT / 1.5" SLOT FOR PAD
442C	1" O/S SUMMER / WINTER FIXED THORACIC / HIP	5 HOLES / 1/2" SPACING
443	2" OFFSET FIXED THORACIC / HIP	3" SLOT / 1.5" SLOT FOR PAD
443B	2" OFFSET FIXED EXTENDED THORACIC / HIP	AS ABOVE / 3.25" BEFORE O/S
443C	2" OFFSET SUMMER/WINTER FIXED THORACIC / HIP	5 HOLES / 1/2" SPACING



445



450A

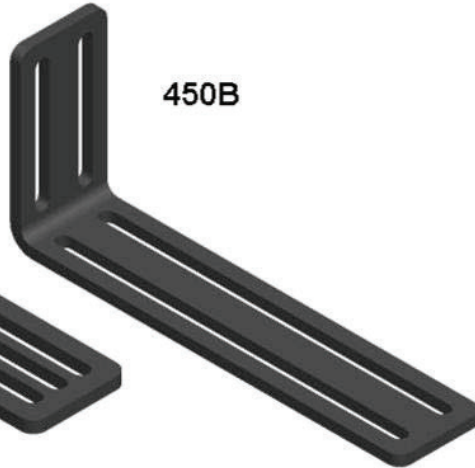

450B



450C



452



453A



453B



454A

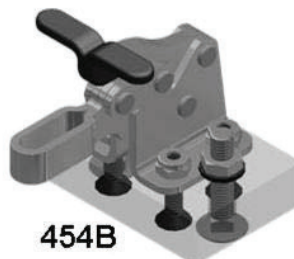

454B



454C



PART No.	DESCRIPTION	SIZE
445	FLAT DUAL SLOT BRACKET / MULTIPLE APPLICATIONS	5" SLOT / 1" SPACING
450A	L-BRACKET THORACIC / HIP	5" FRONT SLOT / 3" REAR
450B	L-BRACKET EXTENDED THORACIC / HIP	8" FRONT SLOT / 3" REAR
450C	L-SUMMER / WINTER THORACIC / HIP ASSEMBLY	5" SLOT / 5 HOLES
452	L-BRACKET HEADREST MOUNT	3" TOP SLOT / 1.25" BOTTOM
453A	ABDUCTOR BRACKET / FLIP—LONG EE3E	7" LONG X 2" WIDE
453B	ABDUCTOR BRACKET / FLIP—SHORT EE3E	3.5" LONG X 2" WIDE
454A	ADJUST KNOB TRAY RELEASE HARDWARE	N/A
454B	TOGGLE CLAMP RELEASE TRAY HARDWARE	N/A
454C	MOUNTING STRAPS TRAY HARDWARE	N/A



455A



455A-M



455B



455C



455C-M



455D

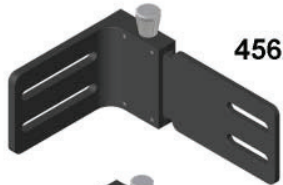

456A

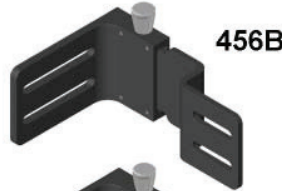

456B

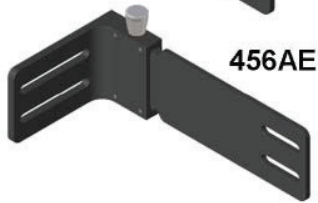

456AE

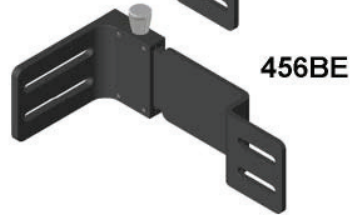

456BE



456D



456H

No Longer Available

New Part #
456H-B



456E



456F



456EE



456FE



PART No.	DESCRIPTION	SIZE
455A	LOCKING SWING AWAY THORACIC / SHORT ASSEMBLY	3" REAR SLOT / 2" FRONT
455A-M	LOCKING SWING AWAY THORACIC / SHORT ASSEMBLY-MICRO	2 3/4" REAR SLOT / 1" FRONT
455B	LOCKING SWING AWAY THORACIC / LONG ASSEMBLY	3" REAR SLOTS / 5" FRONT
455C-M	LOCKING SWING AWAY THORACIC / 1" OFFSET ASSEMBLY—MICRO	2 3/4" REAR SLOT / 1 1/4" FRONT
455C	LOCKING SWING AWAY THORACIC / 1" OFFSET	7" LONG X 2" WIDE (front plate longer)
455D	LOCKING SWING AWAY THORACIC / 2" OFFSET	N/A
456A	QUICK RELEASE LATERAL / HIP L- BRACKET	2.75" REAR SLOT / 1.5" FRONT
456AE	QUICK RELEASE LATERAL / HIP L- BRACKET—EXTENDED	2.75" REAR SLOT / 1.5" FRONT
456B	QUICK RELEASE LATERAL / HIP 1" OFFSET BRACKET	2.75" REAR SLOT / 1.5" FRONT
456BE	QUICK RELEASE LATERAL / HIP 1" OFFSET BRACKET —EXTENDED	2.75" REAR SLOT / 1.5" FRONT
456D	QUICK RELEASE LATERAL / HIP RECEIVER BRACKET	2.75" LONG SLOT
456DE	QUICK RELEASE LATERAL / HIP RECEIVER BRACKET—EXTENDED	2.75" LONG SLOT
456E	QUICK RELEASE LATERAL / HIP PLATE L-BRACKET	1.5" LONG SLOT
456EE	QUICK RELEASE LATERAL / HIP PLATE L-BRACKET—EXTENDED	1.5" LONG SLOT
456F	QUICK RELEASE LATERAL / HIP PLATE 1" OFFSET BRACKET	1.5" LONG SLOT
456FE	QUICK RELEASE LATERAL / HIP PLATE 1" OFFSET BRACKET—EXTENDED	1.5" LONG SLOT
456G	QUICK RELEASE LATERAL / HIP PLATE 2" OFFSET BRACKET	1.5" LONG SLOT
456GE	QUICK RELEASE LATERAL / HIP PLATE 2" OFFSET BRACKET—EXTENDED	1.5" LONG SLOT
456H	SILVER PULL KNOB ONLY—FOR QUICK RELEASE HIP GUIDE	

No Longer Available



457



458



460B

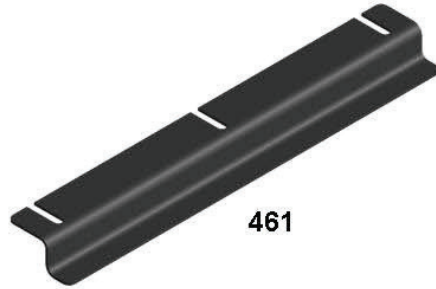

461



462A



462B



462C



462D



462G

No Longer Available



463A

No Longer Available



463B

No Longer Available



463C

No Longer Available



463D

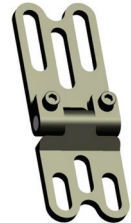

New Part #
463G



464A



464B



464C



464D



464E



464H



464I



PART No.	DESCRIPTION	SIZE
457	QUICK RELEASE FRAME CLAMP	N/A
458	SLIDE GUIDE ABDUCTOR / HEADREST	N/A
460B	HEAVY DUTY FLIP TOP PLATE	2.25" LONG EACH SIDE
461	CHANNEL BRACKETS TRAY HARDWARE	16" LONG / SLOTS 7" APART
462	FRAME CLAMPS EE HARDWARE—ROUND	2.25" LONG SLOTS
462B	FRAME CLAMPS SQUARE / THRU	2.25" LONG SLOTS
462C	FRAME CLAMPS SQUARE / AROUND	N/A
462D	FRAME CLAMPS—FOR QTS FOLDING TILT	
462G	FRAME CLAMPS—MICRO SIZE FOR ECONO-EZE	
463A	ADJUSTABLE HINGE / BI-ANGULAR BACK	1.5" LONG SLOTS
463B	ADJUSTABLE HINGE / HEADREST	1.5" LONG SLOT
463C	ADJUSTABLE HINGE—EASY CONFORMING BACK—15" AND NARROWER WHEELCHAIR	1.25" LONG SLOT
463D	ADJUSTABLE HINGE—EASY CONFORMING BACK—16" AND WIDER WHEELCHAIR	1.25" LONG SLOT
464A	SINGLE TRACKS—11"	11"
464B	SINGLE TRACKS—9"	9"
464C	SINGLE TRACKS—7" STANDARD	7"
464D	SINGLE TRACKS—5"	5"
464E	SINGLE TRACKS—3"	3"
464H	DOUBLE TRACKS—9"	9"
464I	DOUBLE TRACKS—11"	11"



HARDWARE

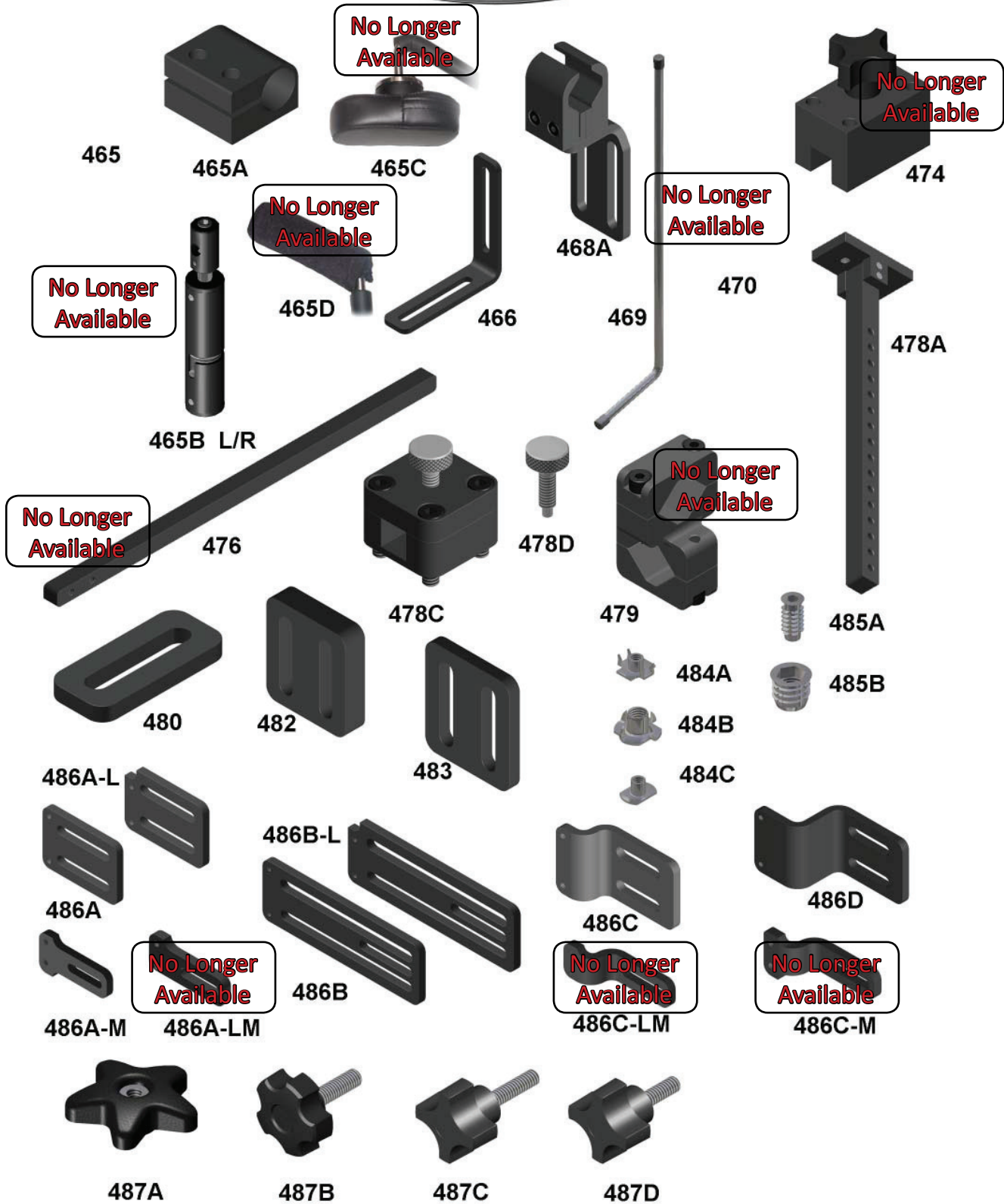



PART No.	DESCRIPTION	SIZE
465	SHOULDER SUPPORT BAR	9.5" BEFORE BEND / 3.5 AFTER
465A	SHOULDER RETRACTOR MOUNT BRACKET	N/A
465B-L	SHOULDER RETRACTOR MECH.—LEFT	N/A
465B-R	SHOULDER RETRACTOR MECH.—RIGHT	N/A
465C	SHOULDER RETRACTOR BAR—FLAT PAD	9.5" BEFORE BEND
465D	SHOULDER RETRACTOR BAR—CONTOURED PAD	9.5" BEFORE BEND
466	L-BRACKET SINGLE SLOT—MULTI APPLICATION	3" LONG SLOTS
467A	HEADREST TOP PLATE MULTI ADJUSTABLE MOUNT	2" SLOTS / 1" SPACE
468A	THORACIC LATERAL SUPPORT FIXED BACKPOST MOUNT - 1"	N/A
468B	THORACIC LATERAL SUPPORT FIXED BACKPOST MOUNT - 7/8"	N/A
468C	THORACIC LATERAL SUPPORT FIXED BACKPOST MOUNT - 3/4"	N/A
469	BENT ROD WITH BALL END—KNEE BLOCKER	15.75" LONG BEFORE BEND
470	KNEE BLOCKER MOUNTING BAR	11.5" LONG BEFORE BEND
474	MOUNTING BLOCK—HARD HALO	N/A
476	MOUNTING POST—HARD HALO	13.5" LONG
478A	POST-HEADREST / ARMREST	5.5" OR 8" LONG
478C	PULL KNOB ASSEMBLY—HEADREST / ARMREST POST	4 T-NUTS , SQUARE 1"
478D	BRASS PULL KNOB for HEADREST HARDWARE 7704	N/A
479	KNEE BLOCKER CLAMP	N/A
480	SPACERS—SINGLE SLOT—1/4" THICK	1.75" LONG SLOT
482	SPACERS—DUAL SLOT—1/2" THICK	1.75" LONG SLOT / 1" SPACE
483	SPACERS—DUAL SLOT—1/4" THICK	1.75" LONG SLOT / 1" SPACE
484A	T-NUTS—1/4-20	N/A
484B	T-NUTS—7/16-16	N/A
484C	TRACK NUT	N/A
485A	BEE STINGER—1/4-20	N/A
485B	BEE STINGER—7/16-20	N/A
486A	SWING AWAY LAT. SUP. FRONT MOUNT PLATE	2" LONG SLOTS
486A-M	SWING AWAY LAT.SUP. FRONT MOUNT PLATE FOR LIFT TYPE—MICRO	1" LONG SLOTS
486A-L	SWING AWAY LAT.SUP. FRONT MOUNT PLATE FOR LEVER	2" LONG SLOTS
486A-LM	SWING AWAY LAT.SUP. FRONT MOUNT PLATE FOR LEVER—MICRO	1" LONG SLOTS
486B	SWING AWAY LAT. SUP. FRONT MOUNT PLATE, LONG	5" LONG SLOTS
486B-L	SWING AWAY LAT. SUP. FRONT MOUNT PLATE, LONG—LEVER	5" LONG SLOTS
486C	SWING AWAY THORACIC FRONT MOUNT PLATE, 1" O/S	2" LONG SLOTS
486C-M	SWING AWAY LAT. SUP. FRT MOUNT, 1" OFFSET—LIFT TYPE, MICRO	1.25" LONG SLOTS
486C-L-L	SWING AWAY LAT. SUP. FRONT MOUNT, 1" OFFSET—LEVER, LEFT	2" LONG SLOTS
486C-L-R	SWING AWAY LAT. SUP. FRONT MOUNT, 1" OFFSET—LEVER, RIGHT	2" LONG SLOTS
486C-LM-L	SWING AWAY LAT. SUP. FRT MOUNT, 1" OFFSET—LEVER, LT, MICRO	1.25" LONG SLOTS
486C-LM-R	SWING AWAY LAT. SUP. FRT MOUNT, 1" OFFSET—LEVER, RT, MICRO	1.25" LONG SLOTS
486D	SWING AWAY LAT. SUP. FRONT MOUNT PLATE, 2" OFFSET	2" LONG SLOTS
486D-L-L	SWING AWAY LAT. SUP. FRONT MOUNT PLATE, 2" OFFSET—LEFT	2" LONG SLOTS
486D-L-R	SWING AWAY LAT. SUP. FRONT MOUNT PLATE, 2" OFFSET—RIGHT	2" LONG SLOTS
487A	STAR KNOB, NO STEM—EE S & B	N/A
487B	STAR KNOB, 3/8-16 / HEADREST	N/A
487C	STAR KNOB, 1" STEM	N/A
487D	STAR KNOB, 3/4" STEM	N/A

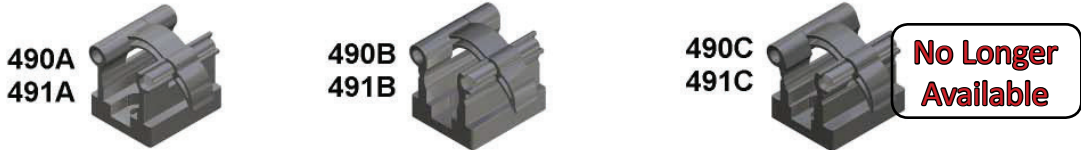
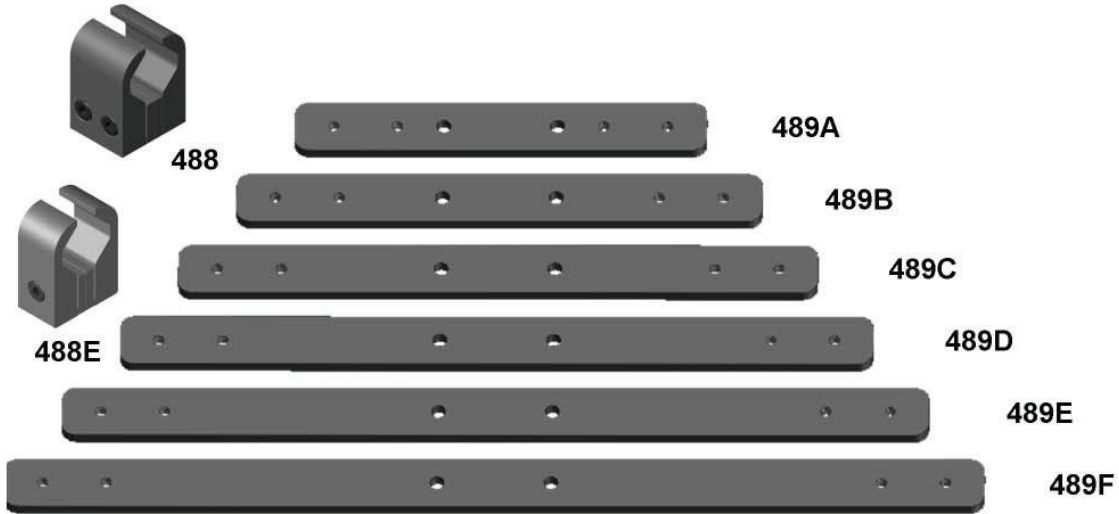



PART No.	DESCRIPTION	SIZE
488	ECONO EZE CLAMP ONLY	N/A
488E	ECONO EZE CLAMP ONLY—MICRO	N/A
489A	SPREADER BAR, 10"-11" WIDE CHAIR	7.25" WIDE
489B	SPREADER BAR, 12"-13" WIDE CHAIR	9.25" WIDE
489C	SPREADER BAR, 14"-15" WIDE CHAIR	11.25" WIDE
489D	SPREADER BAR, 16"-17" WIDE CHAIR	13.25" WIDE
489E	SPREADER BAR, 18"-19" WIDE CHAIR	15.25 WIDE
489F	SPREADER BAR, 20" WIDE AND LARGER CHAIR	17.25" WIDE
490A	SNAP LOCK KIT - 1" (4 EACH)	N/A
490B	SNAP LOCK KIT - 7/8" (4 EACH)	N/A
490C	SNAP LOCK KIT—3/4" (4 EACH)	N/A
491A	SNAPLOCK CLAMP—1"	N/A
491B	SNAPLOCK CLAMP—7/8"	N/A
491C	SANPLOCK CLAMP—3/4"	N/A
492	L-BRACKET CRESCENT S/B MOUNTING	4 HOLES / CRESCENT, .75" SPACING
492S	L-BRACKET CRESCENT STAINLESS S/B MOUNTING	4 HOLES / CRESCENT, .75" SPACING
493	L-BRACKET EXTENDED S/B MOUNTING	6 HOLES / .75" SPACING
493S	L-BRACKET EXTENDED STAINLESS S/B MOUNTING	6 HOLES / .75" SPACING
494A	TWISTER FRAME CLAMP—1"	SEE STD J
494AL	TWISTER FRAME CLAMP with L-BRACKET—1"	SEE STD J/L
494B	TWISTER FRAME CLAMP—7/8"	SEE STD J
494BL	TWISTER FRAME CLAMP with L-BRACKET—7/8"	SEE STD J/L
494C	TWISTER FRAME CLAMP—3/4"	SEE STD J
494CL	TWISTER FRAME CLAMP with L-BRACKET—3/4"	SEE STD J/L
495	KEEPER PLATES	N/A
496A	LOCKING HINGE ONLY—THORACIC	N/A
496A-M	LOCKING HINGE ONLY, LIFT TYPE—THORACIC, MICRO	N/A
496A-L	LOCKING HINGE ONLY, LEVER TYPE—THORACIC	N/A
496AL-M	LOCKING HINGE ONLY, LEVER TYPE—THORACIC, MICRO	N/A
496B	FREE SWING HINGE ONLY—THORACIC	N/A



496C



496C-M



496D

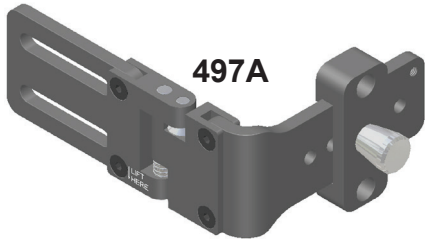

497A



497B

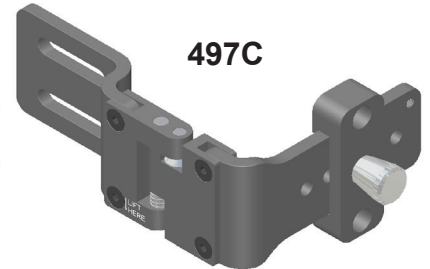

497C

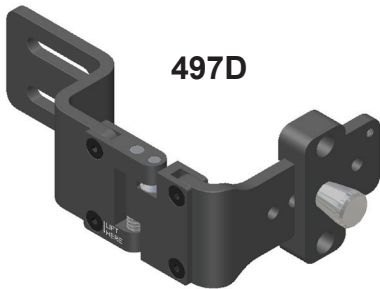

497D



498

No Longer Available

498A

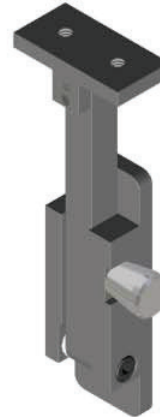

499A



499B

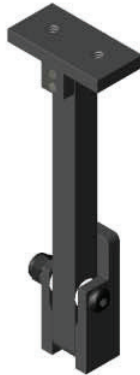

501



504A



504B

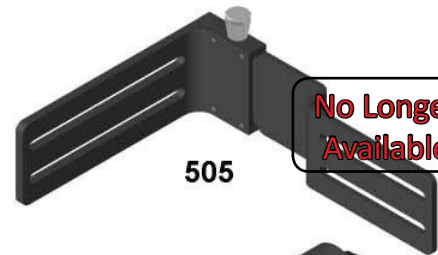

505

No Longer Available



507

No Longer Available



507A

No Longer Available



507B

No Longer Available



508

No Longer Available



PART No.	DESCRIPTION	SIZE
496C	SWING AWAY THORACIC REAR MOUNT PLATE—STD	3" LONG SLOTS
496C-M	SWING AWAY THORACIC REAR MOUNT PLATE—MICRO	2.75" LONG SLOTS
496D	SWING AWAY THORACIC REAR MOUNT PLATE SUMMER / WINTER	5 HOLES / 1/2" SPACING
497A	SWING AWAY THORACIC with SUMMER / WINTER SHORT ASSEMBLY	2" LONG SLOTS / 5 HOLES
		13.25" WIDE
497B	SWING AWAY THORACIC with SUMMER / WINTER LONG ASSEMBLY	5" LONG SLOTS / 5 HOLES
497C	SWING AWAY THORACIC with SUMMER / WINTER 1" OFFSET ASSEMBLY	1.5" LONG SLOTS / 5 HOLES
497D	SWING AWAY THORACIC with SUMMER / WINTER 2" OFFSET ASSEMBLY	1.5" LONG SLOTS / 5 HOLES
498	PULL KNOB with BLOCK—SUMMER / WINTER	N/A
498A	SILVER PULL KNOB FOR SUMMER / WINTER	N/A
499A	PULL KNOB FLIP BACK HARDWARE—SHORT	6" LONG
499B	PULL KNOB FLIP BACK HARDWARE—LONG	9" LONG
501	SLIDE / FLIP HARDWARE	6" LONG
504A	EZ LITE CLAMP—1"	N/A
504B	EZ LITE CLAMP—1" LONG	N/A
505	QUICK RELEASE SEAT /BACK BRACKET	5" with 5.5" LONG SLOT 3.75" TOP
507	EE PIN LOCK FORK—BACK ONLY FORK	2.5" LONG SLOT
507A	ECONO EZE CLAMPS—PIN LOCK	N/A
507B	ECONO EZE CLAMPS, FORK & PLATE—PIN LOCK	N/A
508	ADJUSTABLE ANGLE SEAT / BACK BRACKET	N/A
496A	LOCKING HINGE ONLY—THORACIC	N/A
496A-M	LOCKING HINGE ONLY, LIFT TYPE—THORACIC, MICRO	N/A
496A-L	LOCKING HINGE ONLY, LEVER TYPE—THORACIC	N/A
496AL-M	LOCKING HINGE ONLY, LEVER TYPE—THORACIC, MICRO	N/A
496B	FREE SWING HINGE ONLY—THORACIC	N/A



510A



510A-MC

No Longer Available



510B



510B-MC

No Longer Available



509



510C



510D



511A



511B



511C



511D



PART No.	DESCRIPTION	SIZE
509	NUTS AND BOLTS KIT	N/A
510A	SWING AWAY LEVER RELEASE BRACKET—L	2" LONG SLOTS / 3" REAR
510A-M	MICRO SWING AWAY LEVER RELEASE BRACKET—L	2" LONG SLOT / 3" REAR
510B	SWING AWAY LEVER RELEASE BRACKET—1" OFFSET	1.5" LONG SLOTS / 3" REAR
510B-M	MICRO SWING AWAY LEVER RELEASE BRACKET—1" OFFSET	1.5" LONG SLOT / 3" REAR
510C	SWING AWAY LEVER RELEASE BRACKET—2" OFFSET	1.5" LONG SLOTS / 3" REAR
510D	SWING AWAY LEVER RELEASE BRACKET—EXTENDED	5" SLOTS / 3" REAR
511A	SWING AWAY LEVER RELEASE w/ SUMMER / WINTER L	1.5" LONG SLOTS / 5 HOLES
511B	SWING AWAY RELEASE with SUMMER / WINTER 1" OFFSET	1.5" LONG SLOTS / 5 HOLES
		N/A
511C	SWING AWAY LEVER RELEASE with SUMMER / WINTER 2" OFFSET	1.5" LONG SLOTS / 5 HOLES
511D	SWING AWAY LEVER RELEASE with SUMMER / WINTER EXTENDED	5" LONG SLOTS / 5 HOLES



512A



512B



513A



513B



No Longer Available

513C



514A



514B

514C



PART No.	DESCRIPTION	SIZE
512A	FIXED SEAT / BACK BRACKETS—L	3" SLOT BOTTOM / 5" TOP
512B	FIXED SEAT / BACK BRACKETS EXTENDED L	3" SLOT BOTTOM / 8" TOP
513A	FIXED SEAT / BACK BRACKETS—1" OFFSET	3" SLOT BOTTOM / 1.5" TOP
513B	FIXED SEAT / BACK BRACKET—EXTENDED 1" OFFSET THIS BRACKET IS EXTENDED FOR SEAT THICKNESS	3" SLOT BOTTOM / 1.5" TOP
	SWING AWAY LEVER RELEASE BRACKET—2" OFFSET	1.5" LONG SLOTS / 3" REAR
513C	FIXED SEAT / BACK BRACKETS—EXTENDED 1" OFFSET THIS BRACKET IS EXTENDED FOR BACK ADJUSTMENT	3" SLOT BOTTOM / 4" TOP
514A	FIXED SEAT / BACK BRACKET—2" OFFSET	3" SLOT BOTTOM / 1.5" TOP
514B	FIXED SEAT / BACK BRACKET—EXTENDED 2" OFFSET THIS BRACKET IS EXTENDED FOR SEAT THICKNESS	3" SLOT BOTTOM / 1.5" TOP
514C	FIXED SEAT / BACK BRACKETS—EXTENDED 2" OFFSET THIS BRACKET IS EXTENDED FOR BACK ADJUSTMENT	3" SLOT BOTTOM / 5" TOP

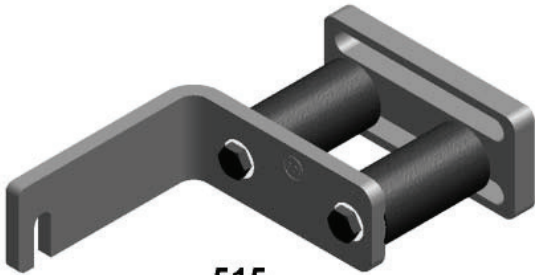

515



516A,B,C



No Longer Available

517



520



521



No Longer Available

523



No Longer Available

524



PART No.	DESCRIPTION	SIZE
515	ECONO-EZE—SPRING LOADED	
516A	ECONO-EZE SPRING—SOFT	
516B	ECONO-EZE SPRING—MEDIUM	
516C	ECONO-EZE SPRING—FIRM	
517	FIXED LATERAL HARDWARE—1" OFFSET/15° BEND.	LEFT AND RIGHT
520	GLIDE LOCK HARDWARE	
521	LEG CRADLE MOUNT CLAMP W/FLAT BRACKET	
523	HARDWARE TETHER	
524	KOALA KIT	

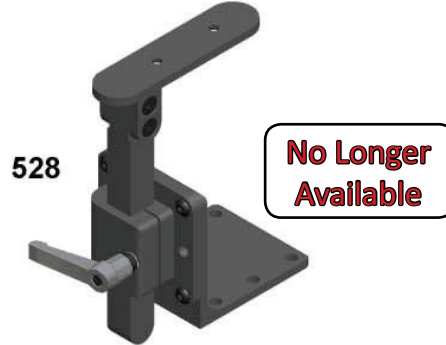



PART No.	DESCRIPTION	SIZE
525	ABDUCTOR—VERTICAL REL. WITH CHILD TOP PLATE	1 1/2" HOLE SPACING
526	ABDUCTOR—VERTICAL REL. WITH SHORT TOP PLATE	1 1/4" LONG SLOTS
527	ABDUCTOR—VERTICAL REL. WITH LONG TOP PLATE	2 SLOTS—1 1/2" LONG
528	ABDUCTOR—VERTICAL REL. WITH 2 HOLE TOP PLATE	1 1/2" HOLE SPACING
529	ABDUCTOR—HORIZONTAL REL. WITH CHILD TOP PLATE	1 1/2" HOLE SPACING
530	ABDUCTOR—HORIZONTAL REL. WITH SHORT TOP PLATE	1 1/4" LONG SLOTS
531	ABDUCTOR—HORIZONTAL REL. WITH LONG TOP PLATE	2 SLOTS—1 1/2" LONG
532	ABDUCTOR—HORIZONTAL REL. WITH 2 HOLE TOP PLATE	1 1/2" HOLE SPACING

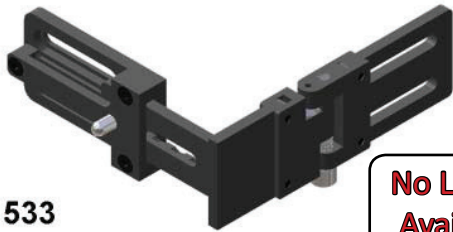

533

No Longer Available

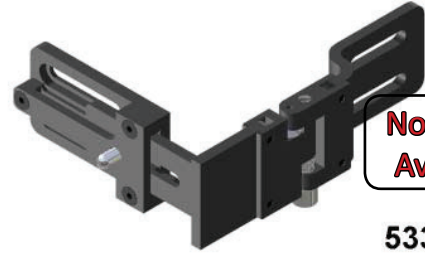

No Longer Available

533A

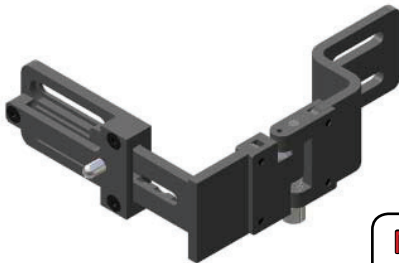

533B

No Longer Available

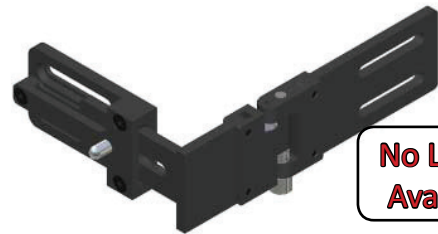

No Longer Available

533C

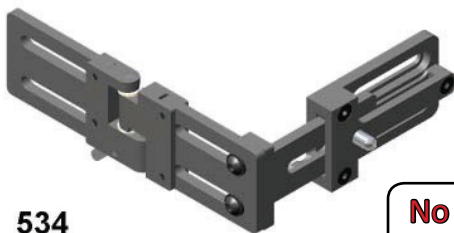

534

No Longer Available

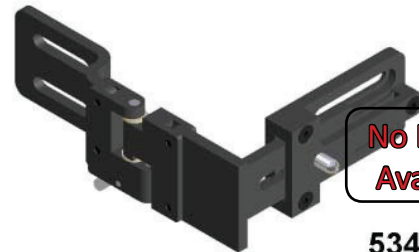

No Longer Available

534A

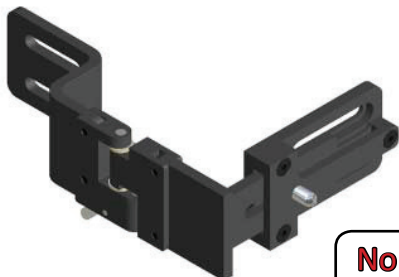

534B

No Longer Available

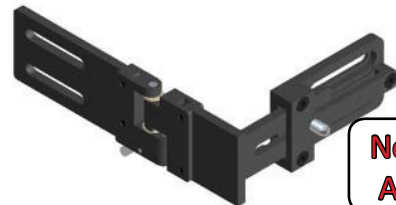

No Longer Available

534C



PART No.	DESCRIPTION	SIZE
533	LATERAL ADJ. GROWTH THORACIC HDW—SWING AWAY—L	
533A	LATERAL ADJ. GROWTH THORACIC HDW—S/A 1" OFFSET	
533B	LATERAL ADJ. GROWTH THORACIC HDW—S/A 2" OFFSET	
533C	LATERAL ADJ. GROWTH THORACIC HDW—S/A—EXTENDED	
534	LAT. ADJ. GROWTH THORACIC HDW—S/A LEVER—L	
534A	LAT. ADJ. GROWTH THORACIC HDW—S/A LEVER—1" O/S	
534B	LAT. ADJ. GROWTH THORACIC HDW—S/A LEVER—2" O/S	
534C	LAT. ADJ. GROWTH THORACIC HDW—S/A LEVER— EXTENDED	

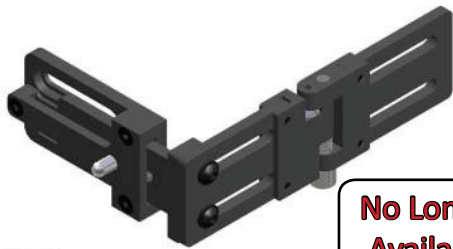

535

No Longer Available

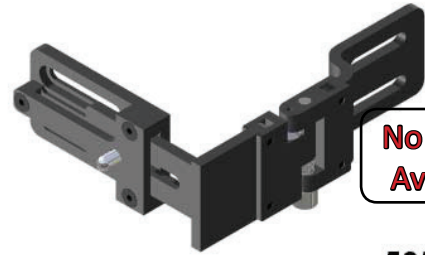

No Longer Available

535A

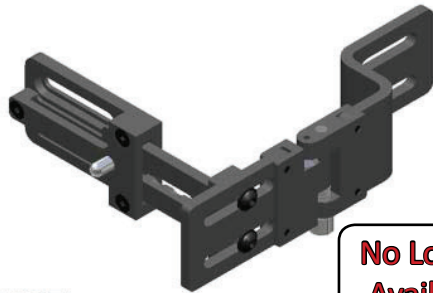

535B

No Longer Available

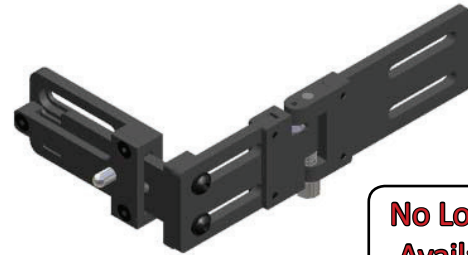

No Longer Available

535C

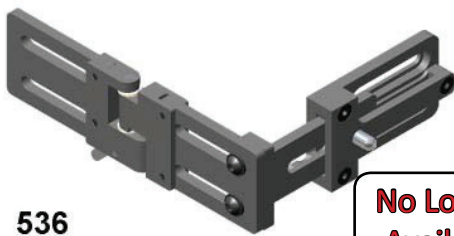

536

No Longer Available



No Longer Available

536A



536B

No Longer Available



No Longer Available

536C



PART No.	DESCRIPTION	SIZE
535	LATERAL WITH DEPTH ADJUSTABLE GROWTH THORACIC HARDWARE—SWING AWAY—L	
535A	LATERAL WITH DEPTH ADJUSTABLE GROWTH THORACIC HARDWARE—SWING AWAY—1" OFFSET	
535B	LATERAL WITH DEPTH ADJUSTABLE GROWTH THORACIC HARDWARE—SWING AWAY—2" OFFSET	
535C	LATERAL WITH DEPTH ADJUSTABLE GROWTH THORACIC HARDWARE—SWING AWAY—EXTENDED	
536	LATERAL WITH DEPTH ADJUSTABLE GROWTH THORACIC HARDWARE—SWING AWAY—LEVER L	
536A	LATERAL WITH DEPTH ADJUSTABLE GROWTH THORACIC HARDWARE—SWING AWAY—LEVER—1" OFFSET	
536B	LATERAL WITH DEPTH ADJUSTABLE GROWTH THORACIC HARDWARE—SWING AWAY—LEVER - 2" OFFSET	
536C	LATERAL WITH DEPTH ADJUSTABLE GROWTH THORACIC HARDWARE—SWING AWAY—LEVER—EXTENDED	

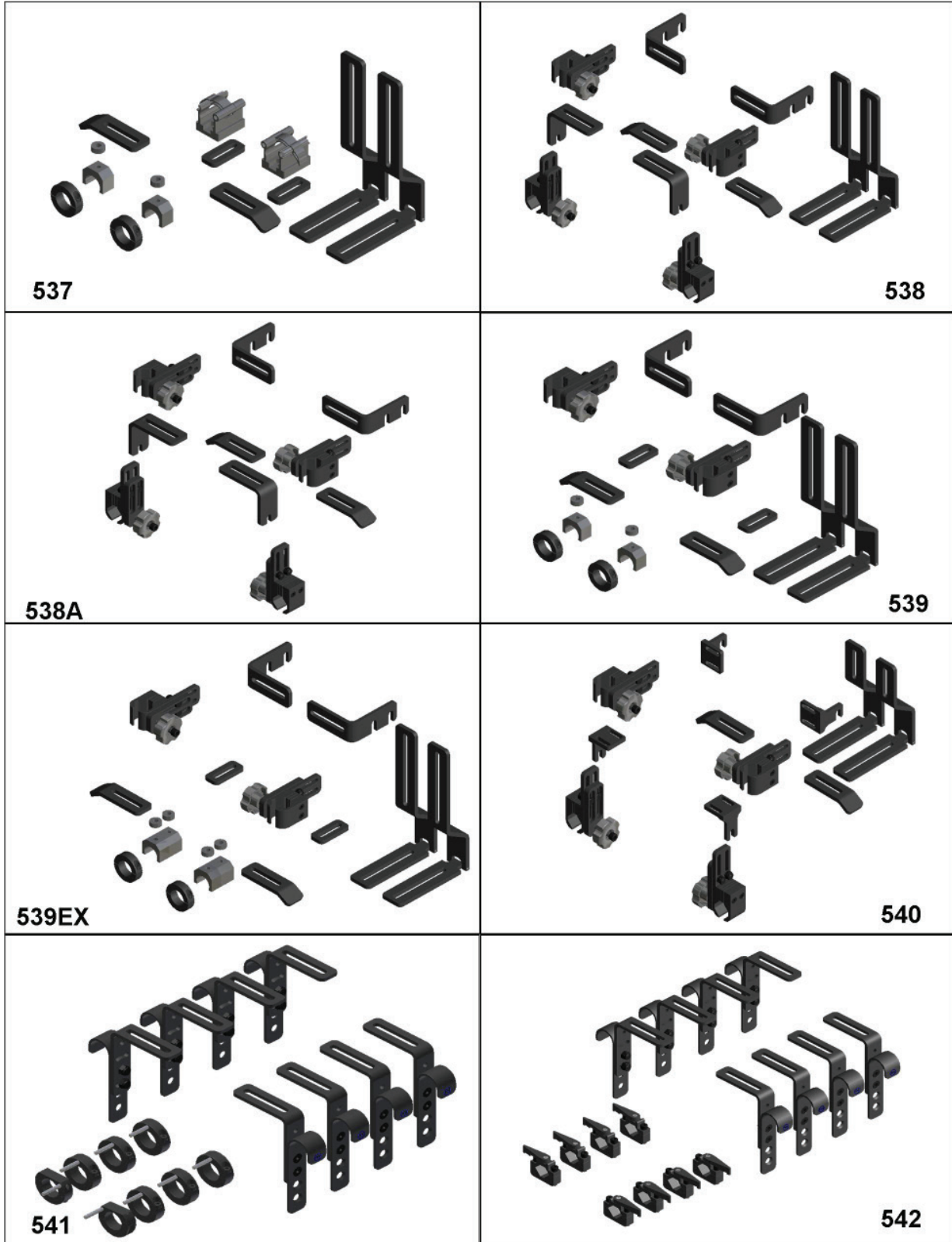



PART No.	DESCRIPTION	SIZE
537	EZ-LITE 1 & EZ-LITE 2—ALL HARDWARE (NO SEAT & BACK)	
538	EE1 & EE2—ALL ADJUSTABLE HARDWARE (NO SEAT & BACK)	
538A	EE1 & EE2—ALL ADJUSTABLE HARDWARE (NO SEAT, BACK OR HINGE) SOLD ONLY WITH PACKAGES E1012PK2, E1013PK4 OR E1013PK5	
539	EZ-LITE 1 & EE2—ALL HARDWARE (NO SEAT & BACK)	
539EX	EZ-LITE 1EXT & EE2—ALL HARDWARE (NO SEAT & BACK)	
540	EE1 MICRO & EE2 MICRO—ALL HARDWARE (NO SEAT & BACK)	
541	101-4000 & 102-4000—ALL HARDWARE (NO SEAT & BACK)	
542	101-7000 & 102-7000—ALL HARDWARE (NO SEAT & BACK)	



543

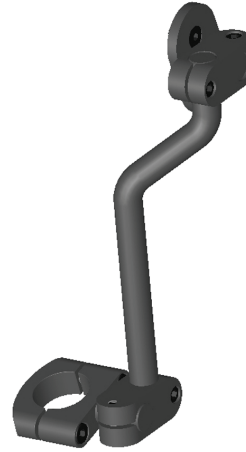

544



No Longer Available

545



No Longer Available

546

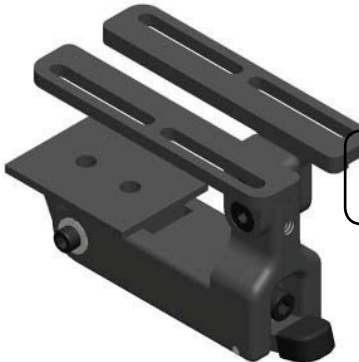

No Longer Available

547



No Longer Available

548



549



549S



PART No.	DESCRIPTION	SIZE
543	HIDE AWAY ABDUCTOR—HARDWARE ONLY	
544	ABDUCTOR KNEE PAD HARDWARE—EACH	
545	FLIP ADJUSTABLE ABDUCTOR HARDWARE WITH CHILD PLATE	
546	FLIP ADJUSTABLE ABDUCTOR HARDWARE WITH SHORT PLATE	
547	FLIP ADJUSTABLE ABDUCTOR HARWARE WITH LONG PLATE	
548	FLIP ADJUSTABLE ABDUCTOR HARDWARE WITH EXTENDED PLATE.	
549	L BRACKET FOR EZ CONFORMING BACK	
549S	L BRACKET FOR EZ CONFORMING BACK—STAINLESS STEEL	

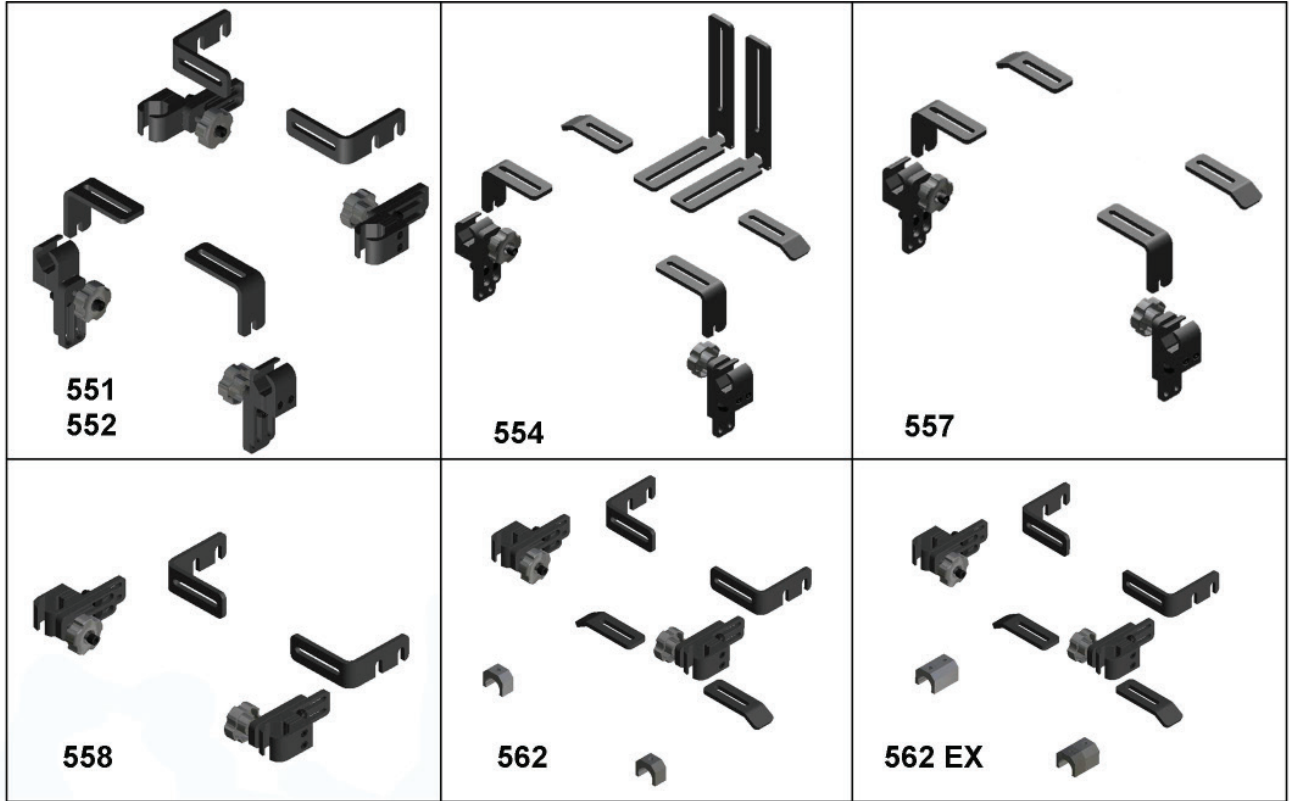



PART No.	DESCRIPTION	SIZE
551	ADJUSTABLE MOUNTING HARDWARE UPGRADE—OMIT EZ-LITE HARDWARE FROM E1012PK3—SUBSTITUTE WITH ECONO EZE ADJUSTABLE, REMOVABLE HARDWARE—SOLD ONLY WITH PACKAGE E1012PK3	
552	ADJUSTABLE MOUNTING HARDWARE UPGRADE—OMIT EZ-LITE HARDWARE FROM E1013PK6—SUBSTITUTE WITH ECONO EZE ADJUSTABLE, REMOVABLE HARDWARE—SOLD ONLY WITH PACKAGE E1013PK6	
553	LOCKING DROP HOOK	
554	SEPARATE MOUNTING HARDWARE FOR SEAT OR BACK CUSHION (ADJUSTABLE)	
555	J/L FOR EAZY CONFORMING BACK—ALUMINUM	
555S	J/L FOR EAZY CONFORMING BACK—STAINLESS STEEL	
556	QUICK RELEASE I.V. POLE HARDWARE	
557	MULTI-ADJUSTABLE SEAT ATTACHMENT MOUNTING HARDWARE	
558	MULTI-ADJUSTABLE BACK ATTACHMENT MOUNTING HARDWARE	
559	EZ LITE TRAY—ADJUSTABLE CHANNEL BRACKET	
560	SPRING LOADED TRAY RELEASE ASSEMBLY FOR PADDED ARMS	
561	LOCKING HOOK TRAY RELEASE FOR 1" TUBULAR ARMS	
562	EZ-LITE 1 & EE2—ALL HARDWARE (NO SEAT & BACK)	
562EX	EZ-LITE 1 EXTENDED & EE2—ALL HARDWARE (NO SEAT & BACK)	
563	QUICK RELEASE HINGED DROP HOOKS FOR VENT TRAY	
564	EE3R MEDIAL THIGH SUPPORT—HARDWARE ONLY	
565	EE3B-2 ABDUCTOR KEEPER PLATE	



566



567



568



No Longer Available

E1012PK3



No Longer Available

E1012PK4



No Longer Available

E1013PK6



No Longer Available

E1013PK7



PART No.	DESCRIPTION	SIZE
566	EASY CLAMP WITH STOPPER RING – NO “L” BRACKET	
567	EASY CLAMP COMPLETE—WITH “L’ BRACKET AND STOP RING	
568	EASY CLAMP STOPPER RING	
E1012PK3	EZ-LITE FIXED MOUNTING HARDWARE, PLANAR SEAT AND PLANAR BACK	
E1012PK4	ECONO-EZE FIXED MOUNTING HARDWARE, PLANAR SEAT AND PLANAR BACK	
E1013PK6	EZ-LITE FIXED MOUNTING HARDWARE., ANTI-THRUST SEAT & CURVED FOAM BACK.	
E1013PK7	ECONO-EZE FIXED MOUNTING HARDWARE., ANTI-THRUST SEAT & CURVED FOAM BACK.	



101-1000PK1

General Use Wheelchair Cushion
(With Wood)

No Longer Available

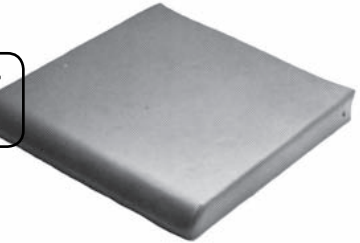

This package includes a flat cushion (with wood) up to 21" of width and depth, 1-1/2" thick 4# foam, Reverse Dartex zipper cover with hook and loop.

101-1000PK2

Skin Protection Wheelchair Cushion
(without Wood)

No Longer Available

This package includes a flat cushion (without wood) up to 21" of width and depth, 1" thick 4# foam with 1 1/2" soft sunmate foam top layer, reverse Dartex zipper cover with hook and loop.

101-1000PK3 Positioning Wheelchair Cushion (with Wood)

No Longer Available

This package includes a contour cushion (with wood) up to 21" of width and depth, Mod-1Y, 1 1/2" medium sunmate foam top layer with posterior hip stabilizers, reverse Dartex zipper cover with hook and loop.

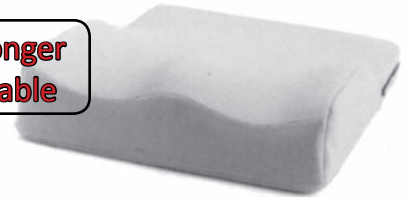

101-1000PK4 Skin Protection & Positioning Wheelchair Cushion (without Wood)

No Longer Available

This package includes a contour cushion (without wood) up to 21" of width and depth, Mod-1Y with 3" of anti-thrust, 1" medium sunmate and 1/2" pudgee overlay and includes posterior hip stabilizers, reverse Dartex zipper cover with hook and loop.

